



ANARIF CO OÜ

— Trader & Supplier —



SURGICAL INSTRUMENTS CATALOGUE

Anarif Co is one of the leading trader & supplier of finest quality Surgical Instruments. We have a large customer base which comprises of private hospitals and renowned Surgical Instruments suppliers all over the world.



ANARIF CO OÜ
Trader & Supplier

SURGICAL INSTRUMENTS

Diagnostics



Buck
AN-1-102-18
20cm,



Buck
AN-1-101-18
Percussion Hammer
18.5 cm,



Dejerine
AN-1-103-20
Percussion Hammer
20cm,



Dejerine
AN-1-104-21
Percussion Hammer
21cm,



Taylor Mod. USA
AN-1-105-20
Percussion Hammer
20cm,



Wartenberg
AN-1-106-19
Pinwheel
18cm,



ANARIF CO OÜ
Trader & Supplier

SURGICAL INSTRUMENTS

Diagnostics



Pinard
AN-1-107-18
Stethoscope
18 cm,



Pinard
AN-1-108-15
Stethoscope
15cm,



Anesthesia



Magill
AN-2-101-15
Catheter Introducing Forceps
14.5 cm, 20 cm, 25 cm,



Miller
AN-2-102-00
Laryngoscope Sets



Miller-Baby
AN-2-103-00
Laryngoscope Sets



Miller
AN-2-104-00
Laryngoscope Blade
Fig. 0, Fig. 1, Fig. 2, Fig. 3, Fig. 4,



Guedel-Negus
AN-2-105-00
Laryngoscope Sets
Fig. 2, Fig. 3, Fig. 4,



Guedel-Negus
AN-2-106-00
Laryngoscope Sets
Fig. 1, Fig. 2, Fig. 3, Fig. 4,



ANARIF CO OU
Trader & Supplier

Anesthesia



Guedel-Negus
AN-2-107-01
Laryngoscope Blades
Fig. 1, Fig. 2, Fig. 3, Fig. 4,



McIntosh
AN-2-108-00



McIntosh
AN-2-109-00
Laryngoscope Blades
Fig. 0, Fig. 1, Fig. 2, Fig. 3, Fig. 4,



McIntosh
AN-2-110-00
Laryngoscope Sets
Fig. 1, Fig. 2, Fig. 3, Fig. 4,



Foregger
AN-2-111-01
Laryngoscope Blades
Fig. 1, Fig. 2, Fig. 3, Fig. 4,



Battery Handle
AN-2-112-00
Battery Handle



Anesthesia



McIntosh
AN-2-114-00
Laryngoscope Sets fiber optic
Fig. 1, Fig. 2, Fig. 3,



McIntosh
AN-2-115-00
Laryngoscope Sets fiber optic
Fig. 1, Fig. 2, Fig. 3,



McIntosh
AN-2-116-00
Laryngoscope Sets fiber optic
Fig. 1, Fig. 2, Fig. 3,



McIntosh
AN-2-113-00
Laryngoscope Sets
Fig. 1, Fig. 2, Fig. 3, Fig. 4,



ANARIF CO OÜ
Trader & Supplier

SURGICAL INSTRUMENTS

Trocars



Universal
AN-3-101-04
Trocar
14 cm,



Nelson
AN-3-102-07
Trocar
20 cm,



Lichtwitz
AN-3-103-19
Antrum Trocar
18.5 cm,



Adson
AN-3-104-21
Suction Cannula
20 cm,



Frazier
AN-3-105-10
Suction Cannula
24 cm,



Frazier
AN-3-106-06
Suction Cannula
19.5 cm,



Trocars



Poppen
AN-3-107-06
Suction Cannula
18 cm,



Luer
AN-3-108-30
Suction Tube working length 110 mm



Yasargil
AN-3-109-15
Suction Tube working length 150 mm with
Luer hub
21.5 cm,



Yankauer
AN-3-110-27
Suction Tube complete with suction tip and
connector
31 cm,



Yankauer
AN-3-111-00
Suction Tube
31 cm, 15 cm, 2.5 cm, 10 cm,



Poole
AN-3-112-22
Suction Tube
22 cm,



ANARIF CO OU
Trader & Supplier

SURGICAL INSTRUMENTS

Trocars



Poole
AN-3-113-22
Suction Tube
22.5 cm,



Nuboer
AN-3-114-21
Suction Tube
21 cm,



Nuboer
AN-3-115-21
Suction Tube
21 cm,



Quinke
AN-3-116-10
Lumbar Puncture Needle



Tuohy
AN-3-117-12
Lumbar Puncture Needle Luer Lock
connection with special tip



Verres
AN-3-118-20
Insufflation Cannula Luer Lock connection
15 cm,



ANARIF CO OÜ
Trader & Supplier

SURGICAL INSTRUMENTS

Trocars



Verres

AN-3-119-20

Insufflation Cannula Luer Lock connection
17 cm,

09



Suture



Kalt
AN-4-105-14
Needle Holder
13.5 cm,



Barraquer-Troutman
AN-4-106-10
Micro Needle Holder
10 cm, 10.5 cm,



Arruga
AN-4-107-14
Micro Needle Holder
13.5 cm,



Barraquer-Troutman
AN-4-108-10
Micro Needle Holder
10.5 cm, 11.5 cm,



Barraquer
AN-4-109-11
Micro Needle Holder
11.5 cm, 13.5 cm, 14 cm,



Barraquer
AN-4-110-13
Micro Needle Holder
13.5 cm,



Suture



Castroviejo-Fino
AN-4-111-01
Micro Needle Holder
13 cm,



Castroviejo-Fino
AN-4-112-01
Micro Needle Holder
13 cm,



Castroviejo-Fino
AN-4-113-01
very delicate jaw with lock
13 cm,

10



Castroviejo
AN-4-114-14
Micro Needle Holder with lock
14 cm,



Castroviejo
AN-4-115-14
Micro Needle Holder
14 cm,



Castroviejo
AN-4-121-14
Micro Needle Holder with lock
14 cm,



Suture



Castroviejo
AN-4-122-14
Micro Needle Holder
14 cm,



Castroviejo
AN-4-124-13
Micro Needle Holder with lock
12 cm,



Arruga
AN-4-123-16
Needle Holder delicate
16 cm,

10



Castroviejo
AN-4-125-12
Micro Needle Holder with lock
12 cm,



Derf
AN-4-126-12
Needle Holder
12 cm, 13 cm,

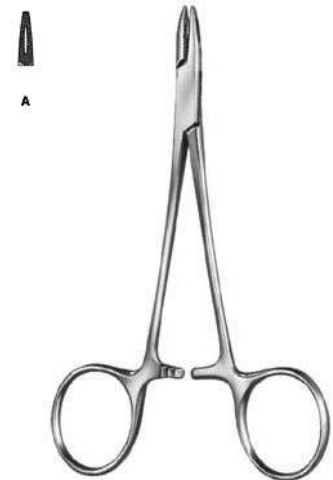

Collier
AN-4-127-12
Needle Holder
12.5 cm,



Suture



Webster
AN-4-128-13
Needle Holder
13 cm,

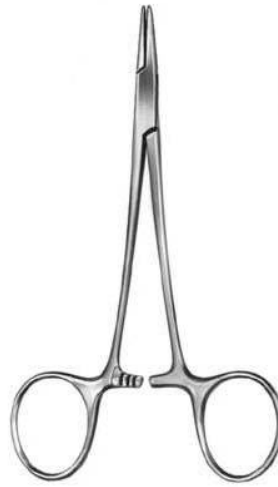

Halsey
AN-4-129-13
Needle Holder
13.5 cm,

10



Neivert
AN-4-130-13
Needle Holder
12.5 cm,



Hegar-Baumgartner
AN-4-131-14
Needle Holder
14.5 cm,



Crile-Murray
AN-4-133-15
Needle Holder
15 cm,



Crile-Wood
AN-4-134-15
Needle Holder
15 cm,



Suture



Adson
AN-4-140-18
Needle Holder one fenestrated jaw
18 cm,



Metzenbaum
AN-4-141-18
Needle Holder one grooved and fenestrated
jaw
18.5 cm,



M. G. Hospital
AN-4-142-17
Needle Holder
17.5 cm,

10

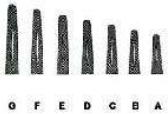

Mayo-Hegar
AN-4-143-14
Needle Holder
14.5 cm, 16 cm, 18.5 cm, 20.5 cm, 24 cm, 26.5
cm,



Mayo-Hegar
AN-4-144-16
Needle Holder
16 cm, 18.5 cm, 20.5 cm,



Brown
AN-4-145-13
Needle Holder
13 cm, 18 cm,



Suture

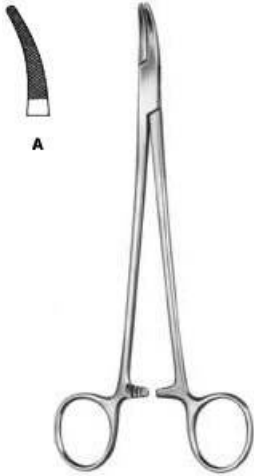

Heaney
AN-4-146-21
Needle Holder
20.5 cm,

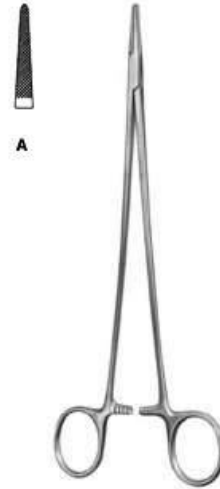

Jamison
AN-4-147-23
Needle Holder
23.5 cm,



Masson
AN-4-148-27
Needle Holder
26.5 cm,

10

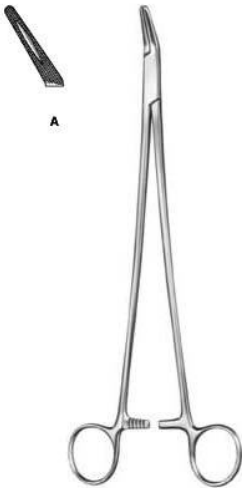

Finochietto
AN-4-149-27
Needle Holder
26.5 cm,



Wangensteen
AN-4-150-27
Needle Holder
26.5 cm,

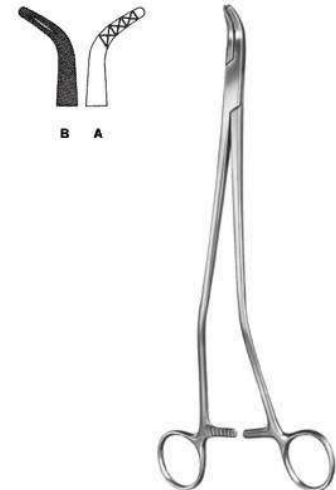

Johnson
AN-4-151-27
Needle Holder
27 cm,



Suture

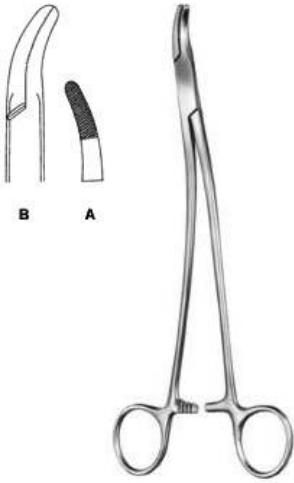

Stratte
AN-4-152-23
Needle Holder
23 cm,

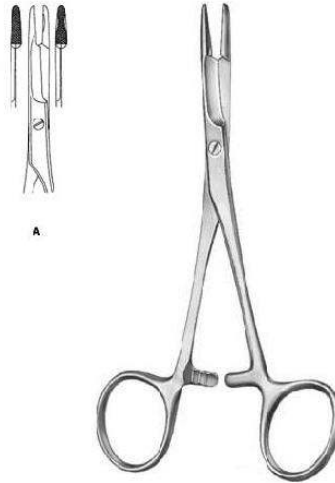

Olsen-Hegar
AN-4-153-14
Needle Holder
14 cm,

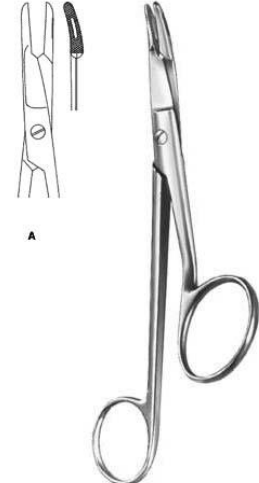

Gillies
AN-4-154-16
Needle Holder
16 cm,



Crile
AN-4-155-15
Needle Holder
15 cm,



Mathieu
AN-4-156-14
Needle Holder
14 cm, 17 cm, 20 cm,



Mathieu
AN-4-157-14
Needle Holder
14 cm, 16.5 cm,

10



Suture



Toennis
AN-4-158-18
Needle Holder
18.5 cm,



Lichtenberg
AN-4-159-20
Needle Holder
20 cm,



AN-4-160-16
Micro Needle Holder
16 cm,

10



AN-4-161
Micro Needle Holder
23 cm, 19 cm,



Hepp-Scheidel
AN-4-162-18
Micro Needle Holder smooth jaw
18 cm,



Webster
AN-4-163-13
Needle Holder with automatic release ratchet
also for lefthanders
13 cm, 15 cm,



Suture



AN-4-164-15
Micro Needle Holder
15 cm, 18 cm, 21 cm, 23 cm,



JABOMA
AN-4-165-18
Micro Needle Holder
18 cm,

10



Castroviejo
AN-4-166
Micro Needle Holder
14.5 cm, 18 cm, 21.5 cm,



Arruga
AN-4-167
Needle Holder
16 cm,



Castroviejo
AN-4-168-13
Micro Needle Holder
12.5 cm,



Barraquer
AN-4-169-13
Micro Needle Holder
13 cm,



Suture



Barraquer
AN-4-170-13
Micro Needle Holder
13 cm,



Webster
AN-4-171-13
Needle Holder
13 cm,



Derf
AN-4-173-12
Needle Holder
12 cm,

10

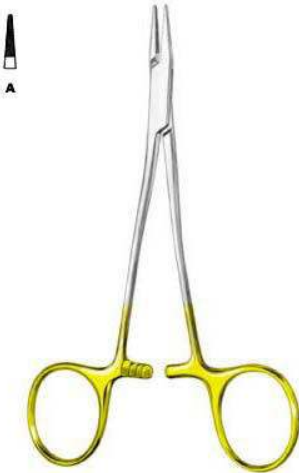

Kilner
AN-4-172-13
Needle Holder
13 cm,



Hegar-Baumgartner
AN-4-174-13
Needle Holder
13 cm, 14.5 cm,



Halsey
AN-4-175-12
Needle Holder
13 cm, 12 cm,



Suture



Crile-Wood
AN-4-176-15
Needle Holder
15 cm,



Sarot
AN-4-177-18
Needle Holder
18 cm, 20 cm, 26 cm,

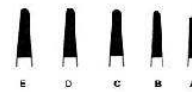

Mayo-Hegar
AN-4-178-16
Needle Holder standard profile
16 cm, 18 cm, 20 cm, 24 cm, 26 cm, 30 cm,

20



Heaney
AN-4-179-20
Needle Holder
20 cm, 24 cm, 26 cm,

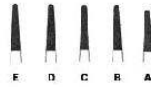

DeBakey
AN-4-180-18
Needle Holder delicate pattern mini profile
18 cm, 20 cm, 23 cm, 26 cm, 31 cm,



Masson
AN-4-181-27
Needle Holder
26.5 cm,



Suture



Barraquer
AN-4-170-13
Micro Needle Holder
13 cm,



Webster
AN-4-171-13
Needle Holder
13 cm,



Derf
AN-4-173-12
Needle Holder
12 cm,

10

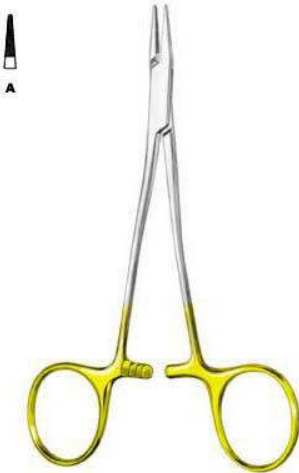

Kilner
AN-4-172-13
Needle Holder
13 cm,



Hegar-Baumgartner
AN-4-174-13
Needle Holder
13 cm, 14.5 cm,



Halsey
AN-4-175-12
Needle Holder
13 cm, 12 cm,



Suture

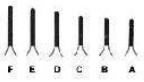

Ryder (Martin)
AN-4-182-13

Needle Holder
12.5 cm, 15 cm, 18 cm, 20 cm, 23 cm, 26 cm,



Martin
AN-4-183-15

Needle Holder mini profile elastic type
15 cm, 17 cm, 20 cm,



Wangenstein
AN-4-184-27

Needle Holder standard profile
27 cm,



Hegar-Vascular
AN-4-185-14

Needle Holder micro profile
14 cm, 18.5 cm, 20.5 cm, 23 cm,

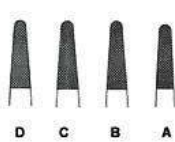

Bozemann
AN-4-186-20

Needle Holder standard profile
20.5 cm, 24 cm, 26.5 cm, 29 cm,



Hegar
AN-4-187-20

Needle Holder standard profile
20 cm, 23.5 cm,



Suture



Lichtenberg
AN-4-194-20
Needle Holder lightweight model standard profile
20 cm,



Langenbeck
AN-4-195-18
Needle Holder
18 cm, 20.5 cm, 23 cm,



Zweifel
AN-4-196-20
Needle Holder with hinged ratchet standard profile
20.5 cm, 23 cm,



Reverdin
AN-4-197-15
Reverdin Needle short
14.5 cm Fig. 1, 14.5 cm Fig. 2, 14.5 cm Fig. 3, 14.5 cm Fig. 4,

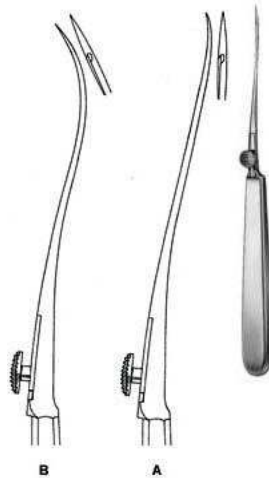

Reverdin
AN-4-198-19
Reverdin Needle medium
19.5 cm Fig. 1, 19.5 cm Fig. 2, 19.5 cm Fig. 3, 19.5 cm Fig. 4,

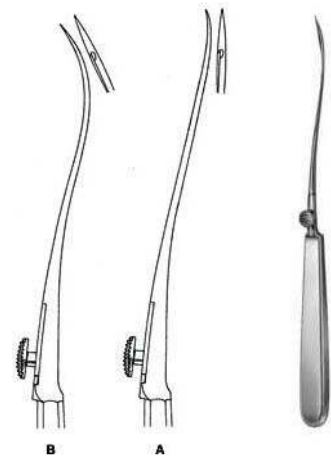

Reverdin
AN-4-199-23
Reverdin Needle long
23 cm Fig. 1, 23 cm Fig. 2, 23 cm Fig. 3, 23 cm Fig. 4,



Suture

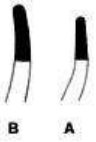

Stratte
AN-4-188-22
Needle Holder standard profile
23 cm,

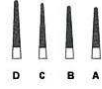

Microvascular
AN-4-189-00
Needle Holder slender pattern micro profile
14 cm, 17.5 cm, 20 cm, 23 cm,

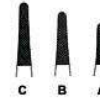

Mathieu
AN-4-190-14
Needle Holder
14 cm, 17 cm, 20 cm,



Mathieu
AN-4-191-14
Needle Holder
14 cm, 17 cm, 20 cm,



Mathieu
AN-4-192-17
Needle Holder standard profile with interior
ratchet
17 cm, 20 cm, 23 cm,



Toennis
AN-4-193-18
Needle Holder
18.5 cm,



Suture

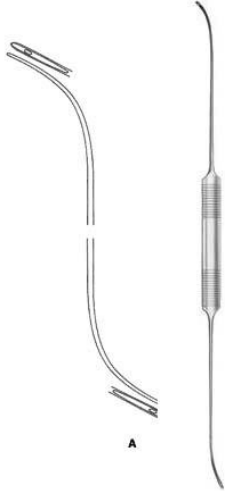

Schmieden-Dick
AN-4-201-01
Ligature Needle malleable
29 cm,

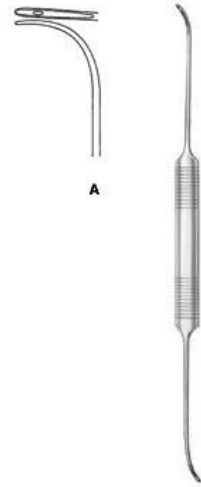

Schmieden
AN-4-202-21
Ligature Needle
24 cm,



AN-4-203-20
Ligature Needle malleable
20.5 cm,

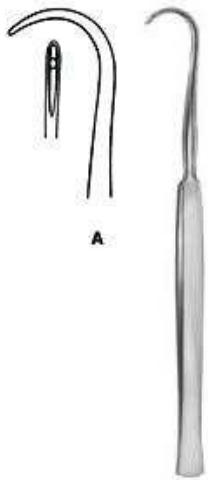

Cooper
AN-4-204-19
Ligature Needle
18.5 cm,



Kronecker
AN-4-205-13
Ligature Needle delicate for right hand
12.5 cm,

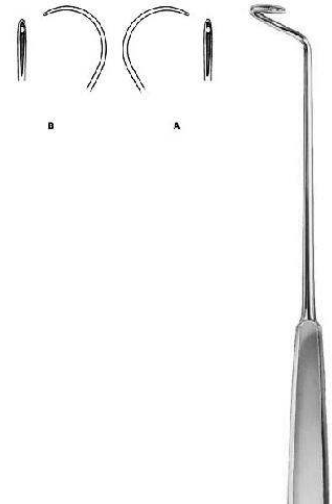

Deschamps
AN-4-206-24
Ligature Needle blunt for right hand
24 cm,



Suture



Deschamps
AN-4-207-20
Ligature Needle blunt for right hand
20 cm,



Deschamps
AN-4-208-20
Ligature Needle sharp for right hand
20 cm,

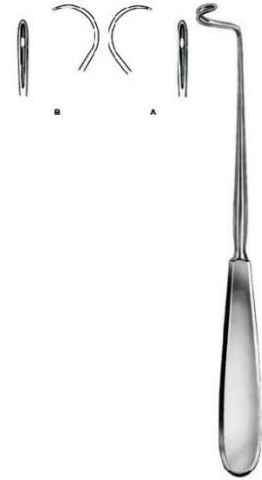

Deschamps
AN-4-209-21
Ligature Needle blunt for right hand
20 cm,



Deschamps
AN-4-210-21
Ligature Needle sharp for right hand
20 cm,

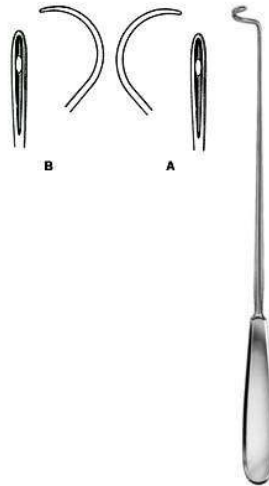

Deschamps
AN-4-211-27
Ligature Needle blunt for right hand
27 cm,

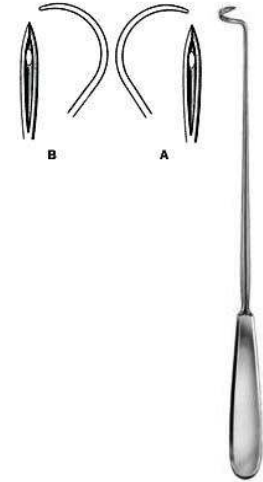

Deschamps
AN-4-212-27
Ligature Needle sharp for right hand
27 cm,



Suture

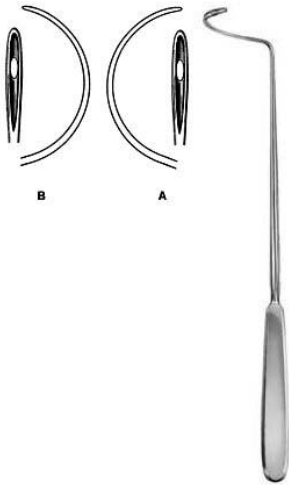

Deschamps
AN-4-213-28
Ligature Needle blunt for right hand
28 cm,



Deschamps
AN-4-214-20
Ligature Needle sharp for right hand
20 cm,



Deschamps
AN-4-215-20
Ligature Needle blunt for right hand
20 cm,



Deschamps
AN-4-216-20
Ligature Needle blunt for right hand
21 cm,

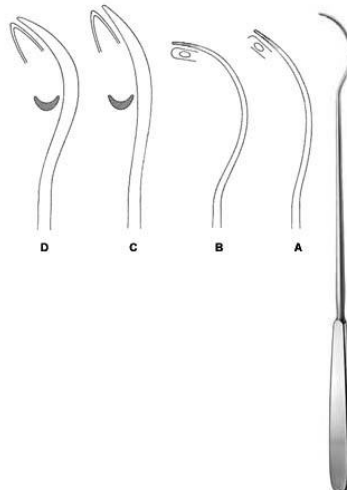

Brunner
AN-4-217-30
Ligature Needle
21 cm,



Kirschner
AN-4-218-25
Ligature Conductor
25.5 cm,



ANARIF CO OÜ
Trader & Supplier

Suture

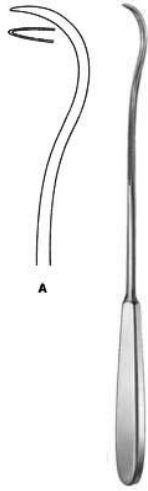

AN-4-219-28
Ligature Conductor
28 cm,



Modell Wien
AN-4-220-23
Ligature Catcher
23.5 cm,



Michel
AN-4-221-12
Clip Applying Forceps
12 cm,



Hegenbarth
AN-4-222-12
Clip Applying Forceps
12 cm,



Scalpels



AN-5-101-01
Dissecting Knife with metal handle
15 cm, 15.5 cm, 16 cm, 17 cm,



AN-5-102-10
Autopsy Knife
25.5 cm,

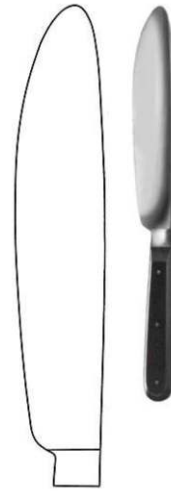

Walb
AN-5-104-17
Post Mortem Knife

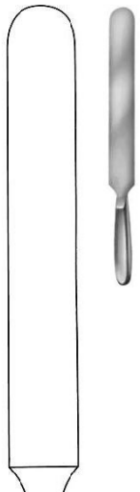

Virchow
AN-5-105-20
Brain Knife with hollow handle
28.5 cm, 33.5 cm, 38 cm,



AN-5-108-04
Scalpel Handle solid
13.5 cm,



AN-5-109-34
Scalpel Handle
16 cm,



ANARIF CO OÜ
Trader & Supplier

SURGICAL INSTRUMENTS

Scalpels



AN-5-110-41
Scalpel Handle solid, long
21 cm,



AN-5-111-45
Scalpel Handle
21 cm,



Collin
AN-5-112-08
Scalpel Handle with hollow handle
13.5 cm,



Collin
AN-5-113-09
Scalpel Handle with hollow handle
14.5 cm,



AN-5-114-03
Scalpel Handle solid
12 cm,



AN-5-115-04
Scalpel Handle
12 cm,



ANARIF CO OÜ
Trader & Supplier

SURGICAL INSTRUMENTS

Scalpels



AN-5-116-05
Scalpel Handle
12 cm,



AN-5-117-31
Scalpel Handle solid, long
21.5 cm,



AN-5-118-35
Scalpel Handle
21 cm,



AN-5-119-07
Scalpel Handle solid
16 cm,



AN-5-120-71
Scalpel Handle solid short
12.5 cm,



AN-5-121-03
Scalpel Handle with round hollow handle
15.5 cm,



Scalpels



AN-5-127-16
Amputation Knife with hollow handle
29 cm,



AN-5-128-19
Amputation Knife with hollow handle
32.5 cm,



Catlin
AN-5-129-16
Interosseous Knife with hollow handle
29cm,



AN-5-130-06
Resection Knife solid handle, dissecting end
18 cm,



Langenbeck
AN-5-131-05
Resection Knife
18 cm,



Langenbeck
AN-5-132-05
Resection Knife
18 cm,



ANARIF CO OÜ
Trader & Supplier

Scalpels



AN-5-133-00

Razor Knife hollow blades on both sides
cutting length 75mm



Schink

AN-5-134-00

Dermatome complete with 2 skin fixing plates
and one blade
31 cm,



Schink

AN-5-135-01

Spare Blade spare blade for KE-05-134-00



Schink

AN-5-136-02

Skin Fixing Plate for KE-05-134-00



ANARIF CO OU
 Trader & Supplier

SURGICAL INSTRUMENTS

Scissors



Standard BL / BL Straight
 AN-5-201-13

Operating Scissor Special
 12 cm, 13 cm, 14.5 cm, 16.5 cm, 18.5 cm, 20.5 cm,



Standard SH / BL STR
 AN-5-202-13

Operating Scissors
 12 cm, 13 cm, 14.5 cm, 16.5 cm, 18.5 cm, 20.5 cm,



Standard SH / SH STR
 AN-5-204-13

Operating Scissors
 12 cm, 13 cm, 14.5 cm, 16.5 cm,



Standard BL / BL Curved
 AN-5-205-13

Operating Scissors
 12 cm, 13 cm, 14.5 cm, 16.5 cm, 18.5 cm, 20.5 cm,

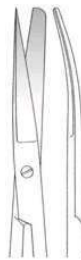

Standard SH / BL Curved
 AN-5-206-13

Operating Scissors
 12 cm, 13 cm, 14.5 cm, 16.5 cm, 18.5 cm, 20.5 cm,



Standard SH / SH Curved
 AN-5-207-13

Operating Scissors
 12 cm, 13 cm, 14.5 cm, 16.5 cm,



Scissors



Standard BL / BL Curved
AN-5-208-14
Operating Scissors delicate
14.5 cm,



Incision Scissor
AN-5-209-14
Operating Scissor
14.5 cm,



Deaver
AN-5-210-14
Operating Scissors



Mayo
AN-5-211-15
Dissecting Scissors
14.5 cm, 15 cm, 17 cm, 23.5 cm, 14.5 cm, 15 cm, 17 cm, 23.5 cm,



Mayo
AN-5-212-23
Dissecting Scissors
23 cm, 22.5 cm, 28 cm,



Mayo-Harrington
AN-5-213-22
Dissecting Scissors
23 cm, 22.5 cm, 28 cm,



ANARIF CO OU
Trader & Supplier

SURGICAL INSTRUMENTS

Scissors

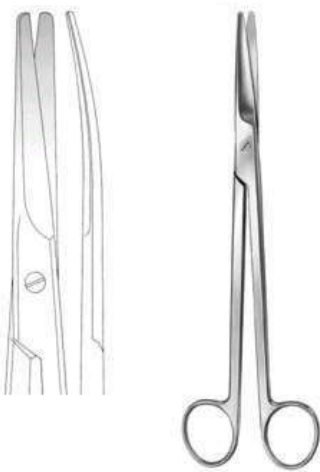

Mayo-Harrington
AN-5-214-22
Dissecting Scissors cur.
22.5 cm, 28 cm, 23 cm,

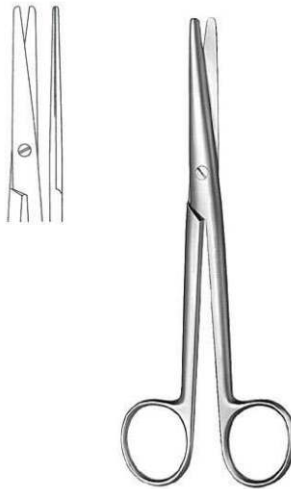

Mayo-Stille
AN-5-215-17
Dissecting Scissors str.
15 cm, 17 cm,

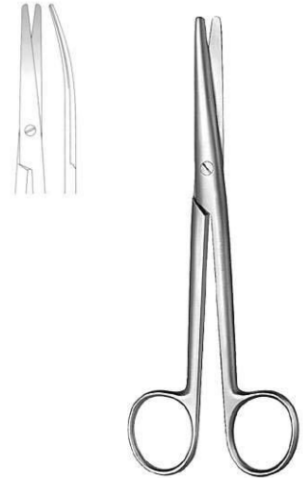

Mayo-Stille
AN-5-216-15
Dissecting Scissors cur.
15 cm, 17 cm,

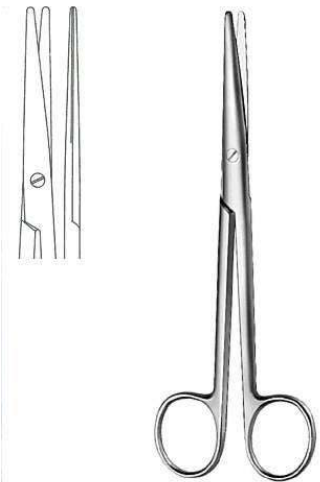

Mayo-Stille
AN-5-217-19
Dissecting Scissors str.
16 cm, 19.5 cm, 21.5 cm,

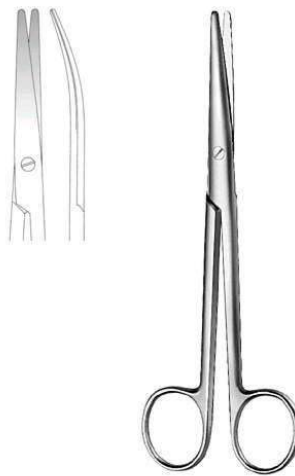

Mayo-Stille
AN-5-218-16
Dissecting Scissors cur.
16 cm, 19.5 cm, 21.5 cm,



Mayo-Noble
AN-5-219-17
Gynecological Scissors
16.5 cm,



Scissors



Sims
AN-5-220-23
Gynecological Scissors str.
20 cm, 23 cm,



Sims
AN-5-221-20
Gynecological Scissors cur.
20 cm, 23 cm,



Kelly
AN-5-222-16
Operating Scissors
16 cm,



Doyen
AN-5-223-17
Gynecological Scissors
18.5 cm,



Sims-Siebold
AN-5-224-24
Gynecological Scissors
24.5 cm,



Sims-Siebold
AN-5-225-24
Gynecological Scissors
24.5 cm,



Scissors



Wertheim
AN-5-226-23
Gynecological Scissors
20 cm, 23 cm,



Metzenbaum
AN-5-227-11
Dissecting Scissors
11.5 cm,



Metzenbaum
AN-5-228-14
Dissecting Scissors
14.5 cm,



Metzenbaum
AN-5-229-15
Dissecting Scissors
15.5 cm,



Metzenbaum-Nelson
AN-5-230-20
Dissecting Scissors
18 cm, 20.5 cm, 23 cm, 26 cm, 28.5 cm, 31 cm,



Metzenbaum-Nelson
AN-5-231-20
Dissecting Scissors
18 cm, 20.5 cm,



Scissors



Lexer
AN-5-238-16
Dissecting Scissors
16 cm,



Cinelli
AN-5-239-14
Nasal Scissors
11.5 cm, 14 cm,



Thorek
AN-5-240-19
Dissecting Scissors
18.5 cm,



Lexer-Baby
AN-5-241-10
Dissecting Scissors
10 cm,



Lexer-Fino
AN-5-242-16
Delicate Dissecting Scissors slender pattern
16.5 cm,



Metzenbaum-Fino
AN-5-243-14
Delicate Dissecting Scissors slender pattern
14.5 cm,



ANARIF CO OU
Trader & Supplier

SURGICAL INSTRUMENTS

Scissors



Metzenbaum-Nelson

AN-5-232-20

Dissecting Scissors

18 cm, 20.5 cm, 23 cm, 26 cm, 28.5 cm, 31 cm,



Metzenbaum

AN-5-233-14

Dissecting Scissors toothed

14.5 cm,



Nerve Operating Scissor

AN-5-234-15

Dissecting Scissors

15.5 cm,

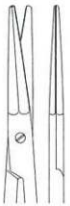

Gorney

AN-5-235-19

Face-lift Scissors str.

12.5 cm, 19.5 cm,

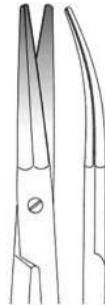

Gorney

AN-5-236-19

Face-lift Scissors cur.

19.5 cm,



Aston

AN-5-237-17

Face-lift Scissors

17 cm,



ANARIF CO OÜ
Trader & Supplier

SURGICAL INSTRUMENTS

Scissors



Metzenbaum-Fino
AN-5-244-14
Delicate Dissecting Scissors
14.5 cm,



Metzenbaum-Fino
AN-5-245-14
Delicate Dissecting Scissors
14.5 cm,



Metzenbaum-Fino
AN-5-246-14
Delicate Dissecting Scissors
14.5 cm,

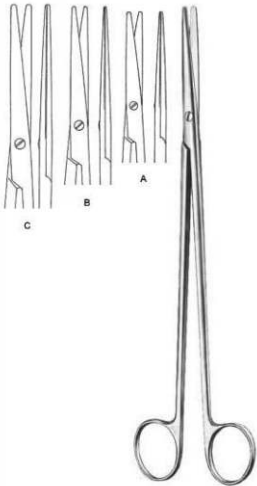

Metzenbaum-Fino
AN-5-247-18
Delicate Dissecting Scissors slender pattern
18 cm, 20 cm, 23 cm,

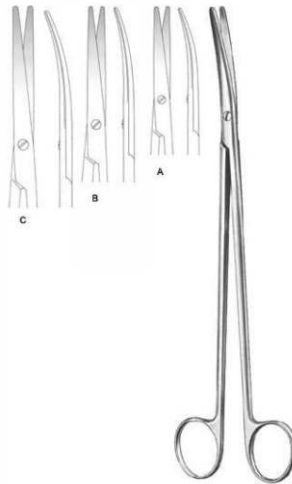

Metzenbaum-Fino
AN-5-248-18
Delicate Dissecting Scissors slender pattern
18 cm, 20 cm, 23 cm,

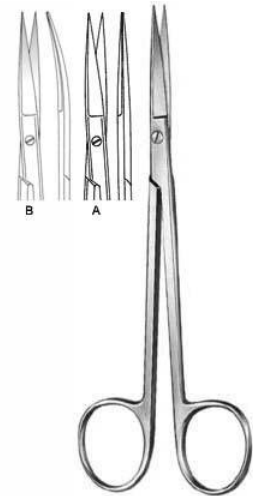

Sanvenero
AN-5-250-14
Operating Scissors
14 cm,



ANARIF CO OÜ
Trader & Supplier

Scissors

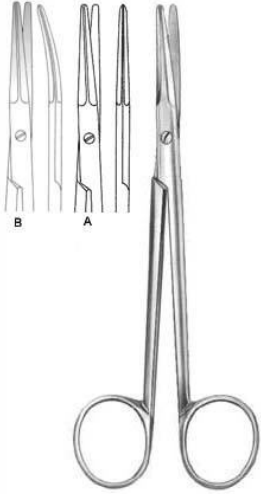

AN-5-257-14
Dissecting Scissors
14.5 cm,

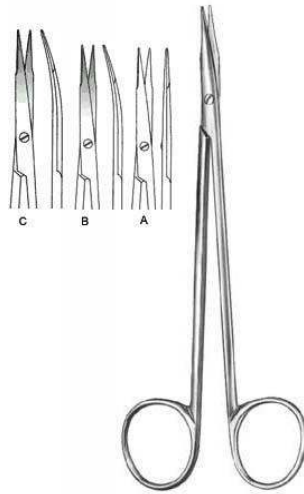

Reynolds
AN-5-258-15
Dissecting Scissors
15.5 cm, 18 cm,



Jameson
AN-5-259-14
Dissecting Scissors
15.5 cm,



Jameson
AN-5-260-14
Dissecting Scissors
15.5 cm,



AN-5-261-19
Vascular Scissors
19 cm,

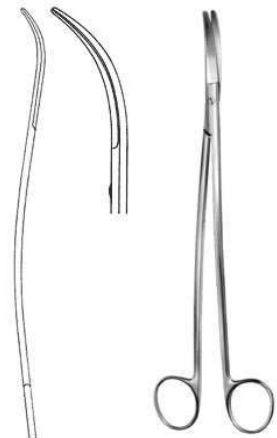

AN-5-262-24
Vascular Scissors fine, short blades
19 cm, 25.5 cm,



ANARIF CO OÜ
Trader & Supplier

Scissors

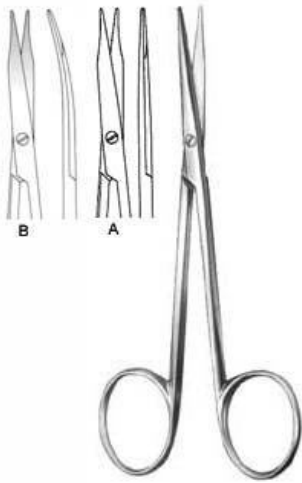

AN-5-251-11
Fine Operating Scissors
11.5 cm,

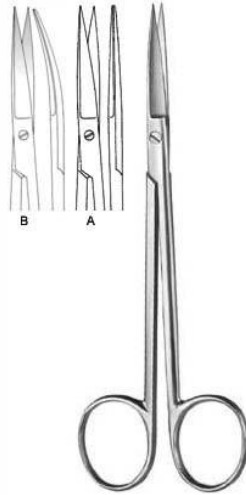

Joseph
AN-5-252-14
Operating Scissors
14.5 cm,

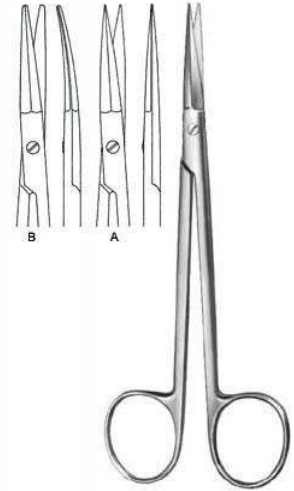

Peck-Joseph
AN-5-253-14
Face-lift Scissors
14.5 cm,

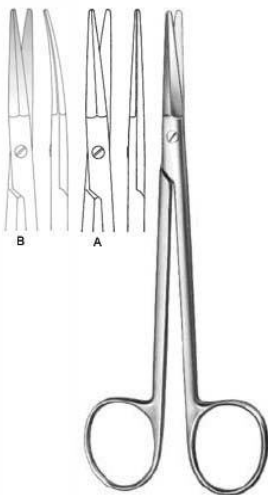

Peck-Joseph
AN-5-254-14
Face-lift Scissors
14.5 cm,



Shea Vein Graft
AN-5-255-12
Dissecting Scissors
12 cm,

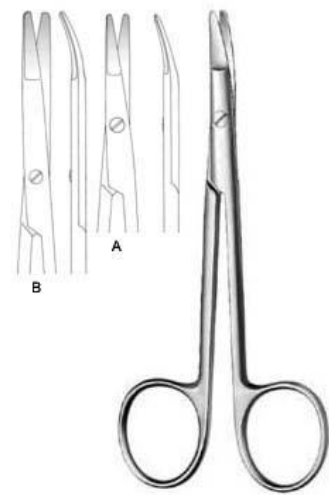

Kilner
AN-5-256-12
Dissecting Scissors
12 cm, 15 cm,



ANARIF CO OU
Trader & Supplier

SURGICAL INSTRUMENTS

Scissors

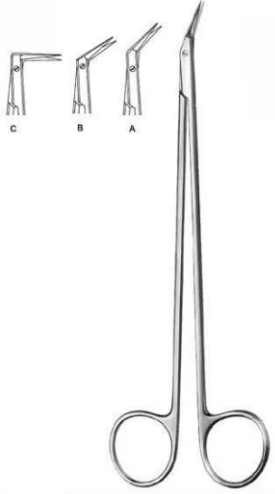

Diethrich
AN-5-263-25
Vascular Scissors
19 cm, 18.5 cm, 17.5 cm,

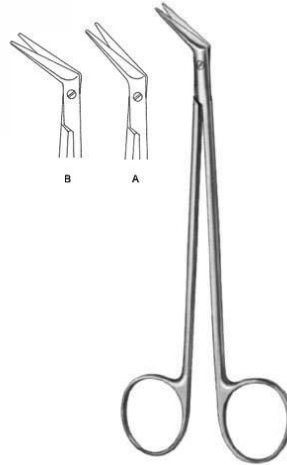

DeBaKey
AN-5-264-45
Vascular Scissors
16.5 cm, 16 cm,

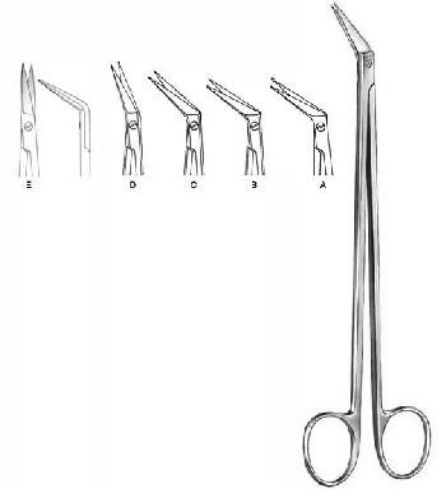

Potts-Smith
AN-5-265-19
Vascular Scissors
18 cm, 18.5 cm, 19 cm,



Coronary Scissors
AN-5-266-25
Cardiovascular Surgery Scissor
18 cm,



Coronary Scissors
AN-5-267-45
Cardiovascular Surgery Scissors
18 cm,



Coronary Scissors
AN-5-268-60
Cardiovascular Surgery Scissor
18 cm,



ANARIF CO OU
Trader & Supplier

SURGICAL INSTRUMENTS

Scissors

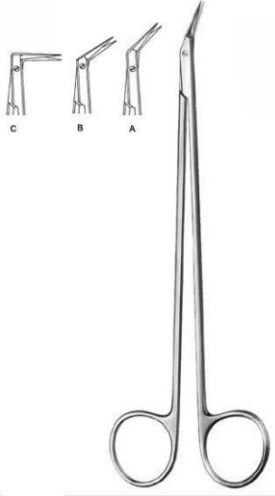

Diethrich
AN-5-263-25
Vascular Scissors
19 cm, 18.5 cm, 17.5 cm,

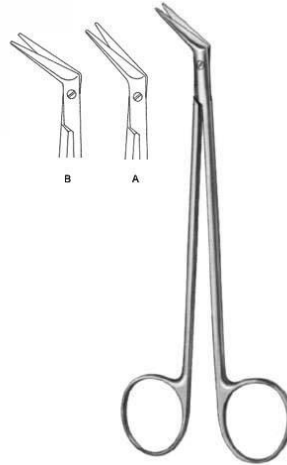

DeBakey
AN-5-264-45
Vascular Scissors
16.5 cm, 16 cm,

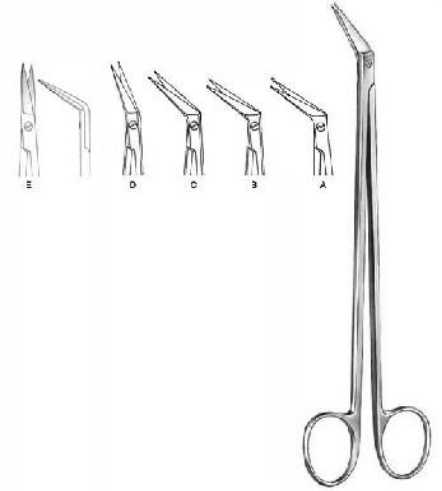

Potts-Smith
AN-5-265-19
Vascular Scissors
18 cm, 18.5 cm, 19 cm,



Coronary Scissors
AN-5-266-25
Cardiovascular Surgery Scissor
18 cm,



Coronary Scissors
AN-5-267-45
Cardiovascular Surgery Scissors
18 cm,



Coronary Scissors
AN-5-268-60
Cardiovascular Surgery Scissor
18 cm,



ANARIF CO OU
Trader & Supplier

SURGICAL INSTRUMENTS

Scissors



Coronary Scissors
AN-5-269-90
Cardiovascular Surgery Scissor
18 cm,



Coronary Scissors
AN-5-270-00
Cardiovascular Surgery Scissor
18 cm,



Coronary Scissors
AN-5-271-00
Cardiovascular Surgery Scissor
18 cm,

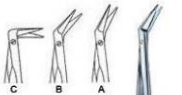

Coronary Scissors
AN-5-272-25
Cardiovascular Surgery Scissor
18 cm,



Coronary Scissors
AN-5-273-45
Cardiovascular Surgery Scissor
18 cm,



Coronary Scissors
AN-5-274-90
Cardiovascular Surgery Scissor
18 cm,



ANARIF CO OU
Trader & Supplier

SURGICAL INSTRUMENTS

Scissors



Coronary Scissors
AN-5-269-90
Cardiovascular Surgery Scissor
18 cm,



Coronary Scissors
AN-5-270-00
Cardiovascular Surgery Scissor
18 cm,



Coronary Scissors
AN-5-271-00
Cardiovascular Surgery Scissor
18 cm,



Coronary Scissors
AN-5-272-25
Cardiovascular Surgery Scissor
18 cm,



Coronary Scissors
AN-5-273-45
Cardiovascular Surgery Scissor
18 cm,



Coronary Scissors
AN-5-274-90
Cardiovascular Surgery Scissor
18 cm,



ANARIF CO OU
Trader & Supplier

SURGICAL INSTRUMENTS

Scissors



Schmieden-Taylor
AN-5-275-17
Dura Scissors
15 cm,



Strully
AN-5-276-22
Neurosurgical Scissors
22.5 cm,



Toennis-Adson
AN-5-277-17
Dissecting Scissors
17.5 cm,



Good
AN-5-279-19
Tonsil Scissors
19.5 cm,



Fomon
AN-5-282-15
Nasal Scissors
15 cm,



Cottle
AN-5-283-16
Nasal Scissors
16 cm,



ANARIF CO OU
Trader & Supplier

SURGICAL INSTRUMENTS

Scissors



Heymann
AN-5-284-18
Nasal Scissors
18.5 cm,



Heymann
AN-5-285-18
Nasal Scissors
18.5 cm,



Converse
AN-5-286-11
Nasal Scissors blunt & sharp
10.5 cm,



Waldmann
AN-5-287-18
Episiotomy Scissors
18 cm,



Braun-Stadler
AN-5-288-14
Episiotomy Scissors
14.5 cm,



Braun-Stadler
AN-5-289-22
Episiotomy Scissors
22 cm,



ANARIF CO OÜ
Trader & Supplier

SURGICAL INSTRUMENTS

Scissors



Modell USA
AN-5-290-10
Umbilical Scissors
10.5 cm,



Busch
AN-5-292-16
Umbilical Scissors
16 cm,



Goldmann-Fox
AN-5-293-13
Gum Scissors
13 cm,



Wagner
AN-5-294-12
Operating Scissors
12 cm,

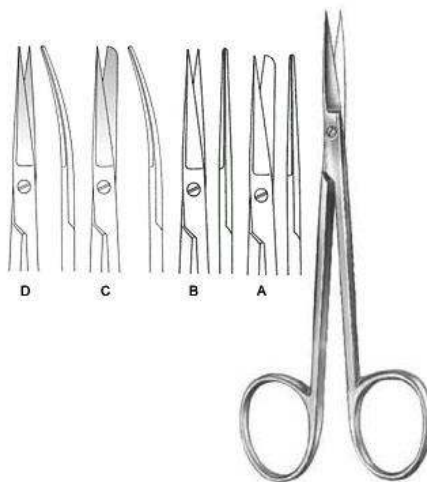

AN-5-295-12
Operating Scissors small model
12 cm,



La Grange
AN-5-296-11
Gum Scissors S-shaped
11.5 cm,



Scissors



AN-5-297-11
Dissecting Scissors delicate
11.5 cm,



Locklin
AN-5-298-16
Gum Scissors
16 cm,



Locklin
AN-5-299-16
Gum Scissors
16 cm,



AN-5-300-08
Operating Scissors very delicate
9 cm,

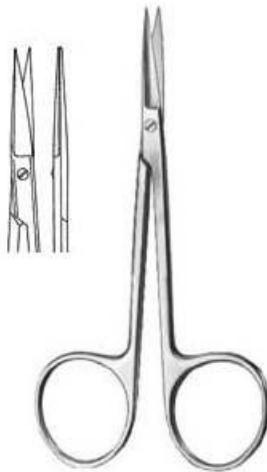

AN-5-301-10
Iris Scissors
9 cm, 10 cm,

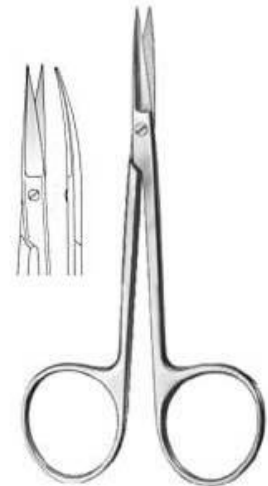

AN-5-302-10
Iris Scissors extra flat blades
10 cm,



Dressing & Tissue Forceps



Standard

AN-5-401-10

Dressing Forceps

10.5 cm, 11.5 cm, 13 cm, 14.5 cm, 16 cm, 18 cm, 20 cm, 23 cm, 25 cm, 30.5 cm,



Standard

AN-5-402-11

Dressing Forceps

12 cm, 13 cm, 14.5 cm, 16 cm, 18 cm, 20 cm, 25 cm, 30 cm,



AN-5-403-13

Dressing Forceps

13 cm, 14.5 cm,



Stille

AN-5-404-15

Dressing Forceps

15 cm,



Mini-Adson

AN-5-405-12

Dressing Forceps

12 cm,



Adson

AN-5-406-12

Dressing Forceps

12 cm, 15 cm,



ANARIF CO OÜ
Trader & Supplier

SURGICAL INSTRUMENTS

Dressing & Tissue Forceps



McIndoe
AN-5-407-15
Dressing Forceps
15 cm,



Waugh
AN-5-408-20
Dressing Forceps
20 cm,



Semken
AN-5-409-12
Dressing Forceps
12.5 cm, 15 cm,



Taylor
AN-5-410-17
Dressing Forceps
12.5 cm, 15 cm,



Taylor
AN-5-411-17
Dressing Forceps
17 cm,



Taylor
AN-5-412-17
Dressing Forceps
18.5 cm,



ANARIF CO OU
Trader & Supplier

SURGICAL INSTRUMENTS

Dressing & Tissue Forceps



AN-5-413-06
Micro Dressing Forceps
15.5 cm,



Gerald
AN-5-414-18
Dressing Forceps
15.5 cm,



Cushing
AN-5-415-17
Dressing Forceps
17.5 cm,



Potts-Smith
AN-5-416-18
Dressing Forceps
18 cm, 21 cm, 24.5 cm,



Bonney
AN-5-417-17
Dissecting Forceps
17.5 cm,



Gerald
AN-5-418-17
Dissecting Forceps
17.5 cm,



ANARIF CO OÜ
Trader & Supplier

SURGICAL INSTRUMENTS

Dressing & Tissue Forceps



Gillies
AN-5-419-15
Dissecting Forceps
15.5 cm,



McIndoe
AN-5-420-15
Dressing Forceps
15 cm,



Semken
AN-5-421-16
Dissecting Forceps
15.5 cm, 17.5 cm,



Adson-Brown
AN-5-422-12
Dissecting Forceps
12 cm,



Adson
AN-5-423-12
Dissecting Forceps
12 cm, 15 cm,



Adson
AN-5-424-12
Dressing Forceps
12 cm, 15 cm,



ANARIF CO OU
Trader & Supplier

Scissors



AN-5-303-10
Iris Scissors extra flat blades
10 cm,



Bonn
AN-5-304-09
Iris Scissors



Dean
AN-5-278-17
Tonsil Scissors
17.5 cm,



Spencer Scissor
AN-5-278-18



Dressing & Tissue Forceps



Cushing
AN-5-425-17
Dressing Forceps
17.5 cm,



Cushing
AN-5-426-18
Dressing Forceps
17 cm,



Cushing-Taylor
AN-5-427-18
Dressing Forceps
18.5 cm,



Potts-Smith
AN-5-428-15
Dressing Forceps
16 cm, 18.5 cm, 20 cm, 23 cm, 25 cm,



Oehler
AN-5-429-14
Dissecting Forceps
14.5 cm, 16 cm, 18 cm, 20 cm, 25 cm,



Wangensteen
AN-5-430-15
Dressing Forceps
15 cm, 23 cm,



Dressing & Tissue Forceps



DeBakey
AN-5-431-15

Atraumatic Dressing Forceps
16 cm, 20 cm, 24.5 cm, 16 cm, 20 cm, 24.5 cm,



DeBakey
AN-5-432-16

Atraumatic Dressing Forceps
16 cm, 20 cm, 24 cm,

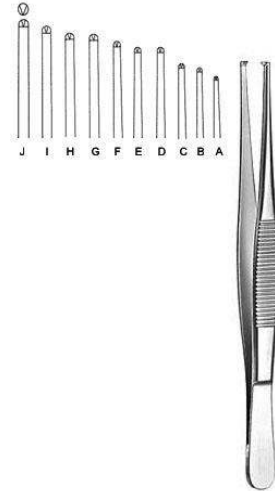

AN-5-433-10

Dissecting Forceps
10.5 cm, 11.5 cm, 13 cm, 14.5 cm, 16 cm, 18 cm, 20 cm, 23 cm, 25 cm, 30.5 cm,

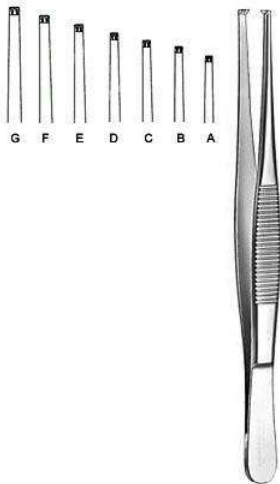

AN-5-434-11

Dissecting Forceps
12 cm, 13 cm, 14.5 cm, 15.5 cm, 18 cm, 20 cm, 24.5 cm,



AN-5-435-14

Dissecting Forceps
14.5 cm, 16 cm,



AN-5-436-14

Dissecting Forceps
14.5 cm, 16 cm,



Dressing & Tissue Forceps



AN-5-437-13
Dissecting Forceps
13 cm, 14.5 cm, 16 cm, 20 cm,



AN-5-438-13
Dissecting Forceps
13 cm, 14.5 cm,



Stille
AN-5-439-15
Dissecting Forceps
15 cm,



Stille
AN-5-440-15
Dissecting Forceps
15 cm,



Stone
AN-5-441-15
Dissecting Forceps
15 cm,



Lerche
AN-5-442-15
Dissecting Forceps
15 cm,



Dressing & Tissue Forceps



Adlerkreutz
AN-5-443-15
Dissecting Forceps
15.5 cm, 20.5 cm, 16 cm, 20 cm, 25 cm,

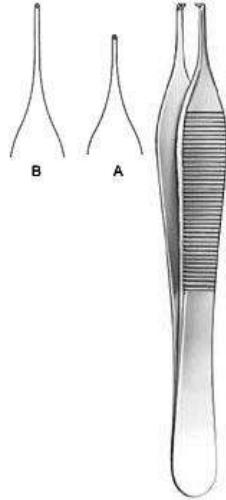

Adson
AN-5-444-12
Dissecting Forceps
12 cm, 15 cm,



Gillies
AN-5-445-15
Dissecting Forceps
15.5 cm,



Waugh
AN-5-446-20
Dissecting Forceps
20.5 cm,



Semken
AN-5-447-12
Dissecting Forceps
12.5 cm, 15 cm,



Taylor
AN-5-448-17
Dissecting Forceps
17.5 cm,



Dressing & Tissue Forceps



Taylor
AN-5-449-17
Dissecting Forceps
17 cm,



Taylor
AN-5-450-17
Dissecting Forceps
18.5 cm,



AN-5-451-06
Micro Dissecting Forceps
15.5 cm,



Gerald
AN-5-452-17
Dissecting Forceps
17.5 cm,



Cushing
AN-5-453-17
Dissecting Forceps
18 cm,



Potts-Smith
AN-5-454-18
Dissecting Forceps
18 cm, 21 cm, 24 cm,



Dressing & Tissue Forceps

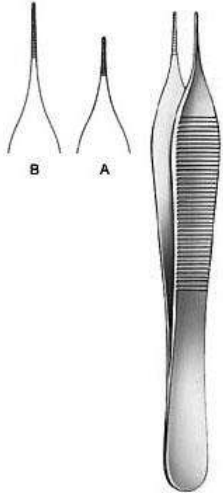

Mikro-Adson
AN-5-455-12
Dressing Forceps
12 cm, 15 cm,

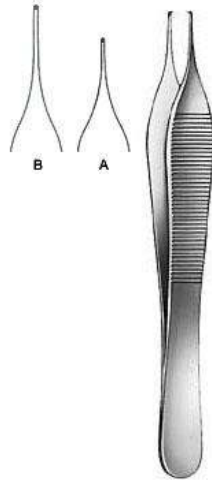

Mikro-Adson
AN-5-456-12
Dissecting Forceps
12 cm, 15 cm,



AN-5-457-11
Dissecting Forceps
10.5 cm,



Micro Jewelers
AN-5-458-12
Jeweler Type Forceps
12 cm Fig. 7,



Jewelers
AN-5-459-12
Jeweler Type Forceps
12 cm Fig. 3,



Jewelers
AN-5-460-11
Jeweler Type Forceps
11 cm Fig. 3c,



Dressing & Tissue Forceps



Jewelers
AN-5-461-11
Jeweler Type Forceps
11 cm Fig. 5,



Jewelers
AN-5-462-11
Jeweler Type Forceps
11 cm Fig. 4,



Stille-Barraya
AN-5-463-18
Dissecting Forceps
18 cm,



Bonney
AN-5-464-18
Dissecting Forceps
17.5 cm,



Nelson
AN-5-465-23
Dissecting Forceps
23 cm,



AN-5-466-10
Dressing Forceps
10 cm, 9.5 cm,



ANARIF CO OÜ
Trader & Supplier

Dressing & Tissue Forceps



AN-5-467-12
Splinter Forceps smooth jaw
12.5 cm,



AN-5-468-12
Splinter Forceps smooth jaw
12.5 cm,



AN-5-469-12
Splinter Forceps
12.5 cm,



AN-5-470-12
Splinter Forceps
12.5 cm,



AN-5-471-16
Micro Tying Forceps
15.5 cm,



AN-5-472-10
Microscopic Forceps super light, blunt
10 cm,



Dressing & Tissue Forceps



AN-5-473-10
Microscopic Forceps
10 cm,



Shaaf
AN-5-474-09
Splinter Forceps
9.5 cm,



Littauer
AN-5-475-08
Cilia Forceps
8.5 cm,



AN-5-476-09
Cilia Forceps
8.5 cm,



Douglas
AN-5-477-09
Cilia Forceps
9 cm,



Douglas
AN-5-478-09
Cilia Forceps
9 cm,



ANARIF CO OÜ
Trader & Supplier

SURGICAL INSTRUMENTS

Dressing & Tissue Forceps

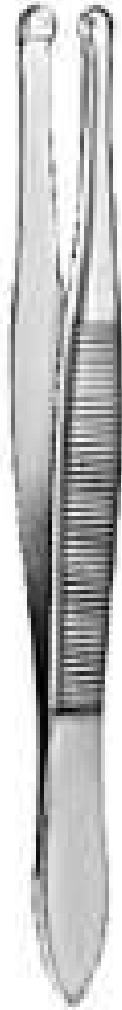

Beer

AN-5-479-09

Cilia Forceps

9 cm,



Splinter Forceps



Phaneuf
AN-5-501-21
Hysterectomy Forceps
20.5 cm,



Wertheim-Cullen
AN-5-502-21
Vaginal Clamp
21 cm,

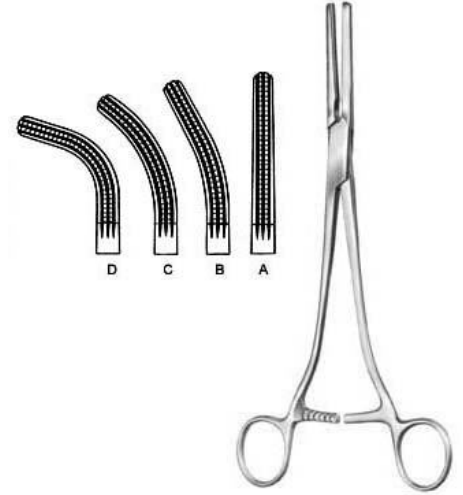

Rogers
AN-5-503-10
Hysterectomy Forceps
21.5 cm Fig. 1, 21 cm Fig. 2, 20.5 cm Fig. 3, 20 cm Fig. 4,



Moynihan
AN-5-504-23
Hysterectomy Forceps
23 cm,



Moynihan
AN-5-505-24
Hysterectomy Forceps
23.5 cm,



Wertheim
AN-5-506-25
Hysterectomy Forceps
26 cm,



Splinter Forceps



Phaneuf
AN-5-501-21
Hysterectomy Forceps
20.5 cm,



Wertheim-Cullen
AN-5-502-21
Vaginal Clamp
21 cm,

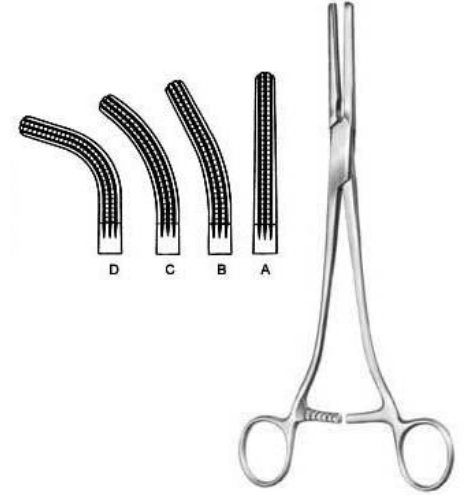

Rogers
AN-5-503-10
Hysterectomy Forceps
21.5 cm Fig. 1, 21 cm Fig. 2, 20.5 cm Fig. 3, 20 cm Fig. 4,



Moynihan
AN-5-504-23
Hysterectomy Forceps
23 cm,



Moynihan
AN-5-505-24
Hysterectomy Forceps
23.5 cm,



Wertheim
AN-5-506-25
Hysterectomy Forceps
26 cm,



Splinter Forceps

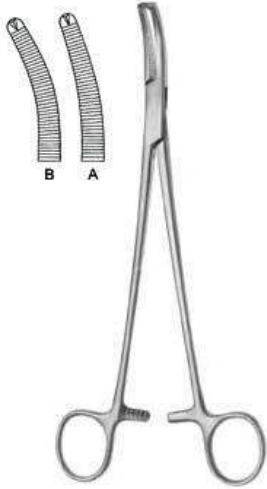

Wertheim
AN-5-507-22
Hysterectomy Forceps
22.5 cm,



Mikulicz, Baby
AN-5-508-14
Peritoneum Forceps
14.5 cm,



Mikulicz
AN-5-509-18
Peritoneum Forceps
20.5 cm,



Mikulicz
AN-5-510-20
Peritoneum Forceps
18.5 cm,



Mikulicz
AN-5-511-20
Peritoneum Forceps
20 cm,



Mikulicz
AN-5-512-21
Peritoneum Forceps
20.5 cm,



ANARIF CO OÜ
Trader & Supplier

SURGICAL INSTRUMENTS

Splinter Forceps



Faure

AN-5-513-20

Peritoneum Forceps

21 cm,



Haemostatic Forceps

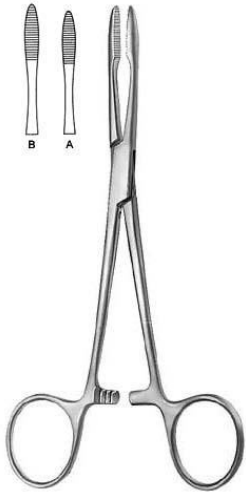

Pean
AN-5-601-14
Haemostatic Forceps
14.5 cm, 16 cm,

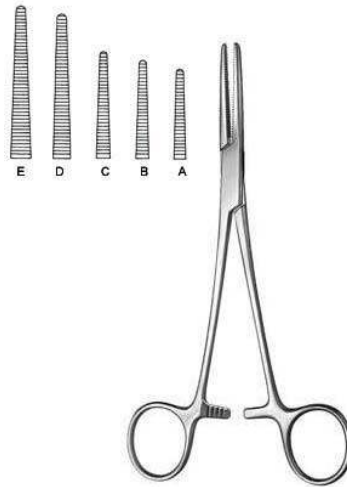

Spencer-Wells
AN-5-602-13
Haemostatic Forceps
13 cm, 14 cm, 15.5 cm, 18.5 cm, 20 cm,

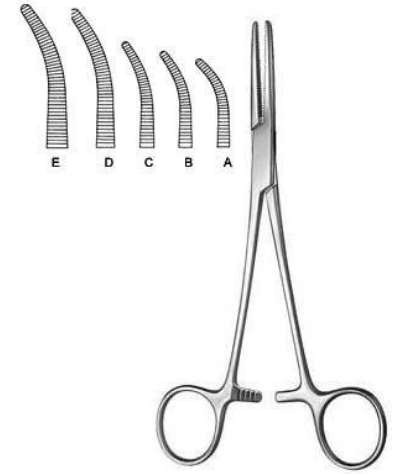

Spencer-Wells
AN-5-603-13
Haemostatic Forceps
13 cm, 14 cm, 15 cm, 18 cm, 20 cm,



Chaput
AN-5-604-13
Haemostatic Forceps



Tuffier
AN-5-605-13
Haemostatic Forceps

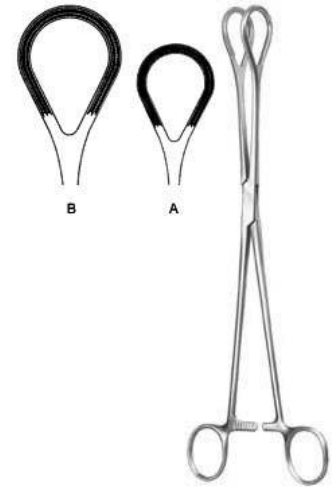

AN-5-606-25
Organ Grasping Forceps



Haemostatic Forceps



Collin
AN-5-607-14
Organ Grasping Forceps
15.5 cm, 21 cm,



Collin
AN-5-608-17
Tumor Grasping Forceps
17 cm,



Pennington
AN-5-609-15
Haemostatic Forceps
15.5 cm,



Pratt
AN-5-610-15
Haemostatic Forceps
15 cm,



Martel-Rees
AN-5-611-14
Face-lift Forceps
13.5 cm,



AN-5-612-12
Ligature Forceps



Haemostatic Forceps



Mixer-Baby
AN-5-613-01
Dissecting and Ligature Forceps
13.5 cm, 13 cm,

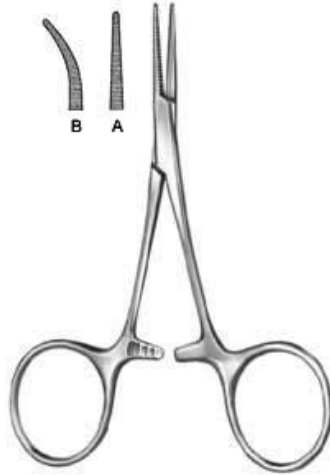

Hartmann
AN-5-614-10
Haemostatic Forceps
10 cm, 9.5 cm,



AN-5-615-12
Ligature Forceps

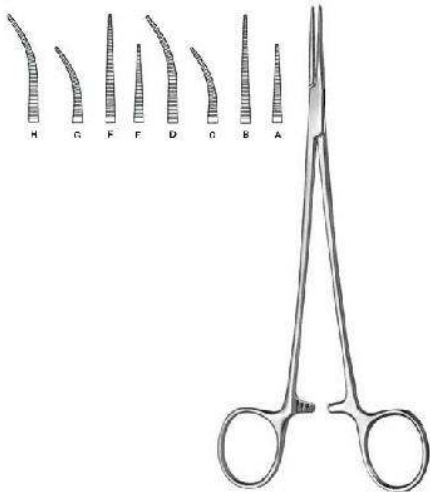

Halsted-Mosquito
AN-5-616-18
Haemostatic Forceps
12.5 cm, 14.5 cm, 14 cm,

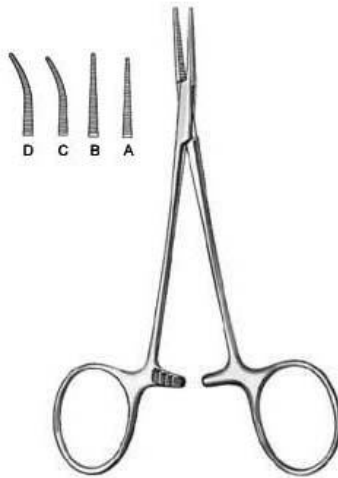

Mikro-Mosquito
AN-5-617-10
Haemostatic Forceps
10 cm, 12 cm, 9.5 cm, 11.5 cm,



Providence-Hospital
AN-5-618-14
Haemostatic Forceps
14 cm,



Haemostatic Forceps



Leriche
AN-5-619-15
Haemostatic Forceps
15.5 cm, 15 cm,

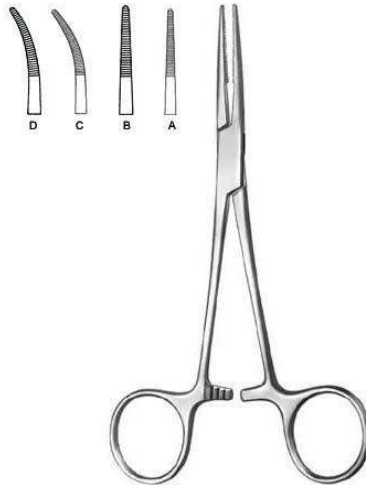

Kelly
AN-5-620-14
Haemostatic Forceps
14.5 cm, 14 cm,

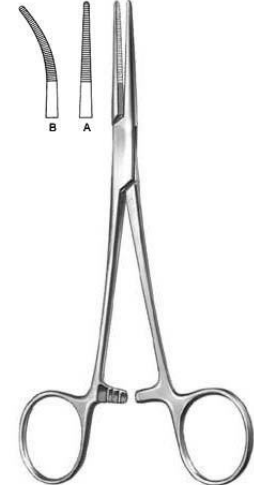

Kelly-Rankin
AN-5-621-16
Haemostatic Forceps
16 cm, 15.5 cm,



Overholt-Baby
AN-5-622-14
Dissecting and Ligature Forceps
14.5 cm, 14 cm,



Crile
AN-5-623-14
Haemostatic Forceps
14.5 cm, 14 cm,



Crile-Rankin
AN-5-624-16
Haemostatic Forceps
16.5 cm, 16 cm,



Haemostatic Forceps

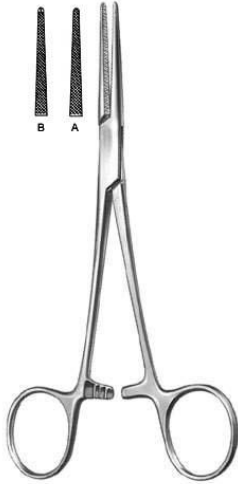

Lovelace
AN-5-625-15
Haemostatic Forceps
16 cm,



Dandy-Mosquito
AN-5-626-12
Haemostatic Forceps
12 cm,

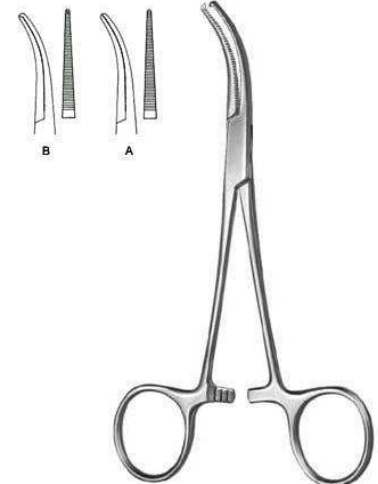

Dandy
AN-5-627-14
Haemostatic Forceps
14.5 cm, 14 cm,



Schidt
AN-5-628-18
Dissecting and Ligature Forceps
18.5 cm, 19 cm,



Adson
AN-5-629-18
Dissecting and Ligature Forceps
19 cm, 18.5 cm,



Martin-Fuchsig
AN-5-630-20
Dissecting and Ligature Forceps
20.5 cm,



Haemostatic Forceps

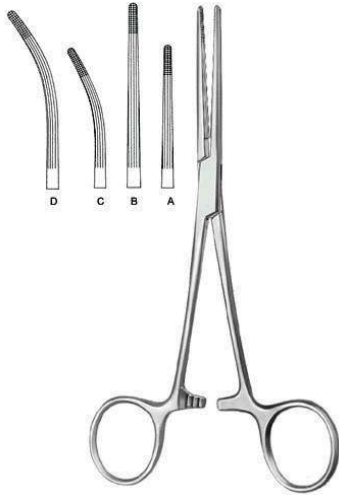

Rochester-Carmalt

AN-5-631-16

Haemostatic Forceps

17 cm, 20.5 cm, 16.5 cm, 20 cm,

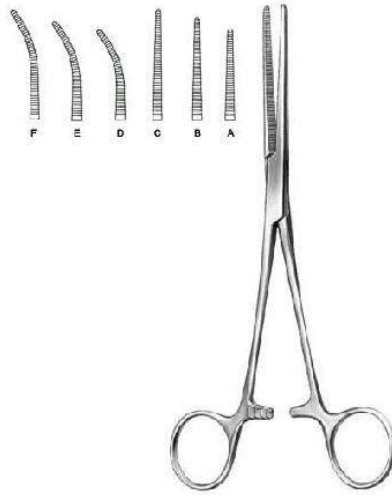

Pean

AN-5-632-13

Haemostatic Forceps

13.5 cm, 14.5 cm, 17 cm, 13 cm, 14 cm, 16.5 cm,

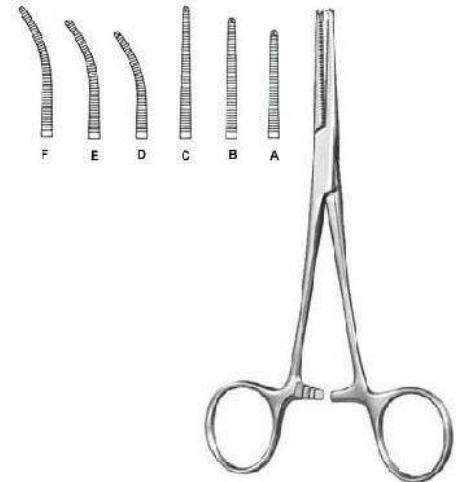

Kocher-Nippon

AN-5-633-14

Haemostatic Forceps

14.5 cm, 16.5 cm, 18.5 cm, 16 cm, 18 cm,

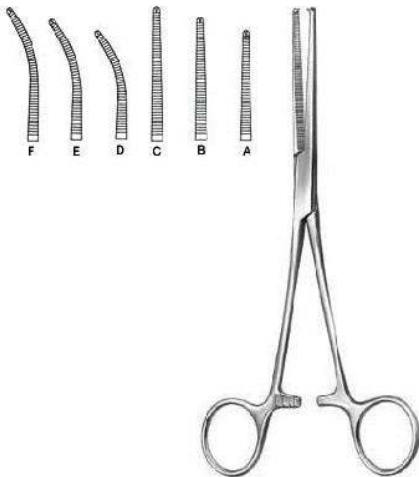

Kocher

AN-5-635-13

Haemostatic Forceps

13 cm, 14 cm, 16 cm,

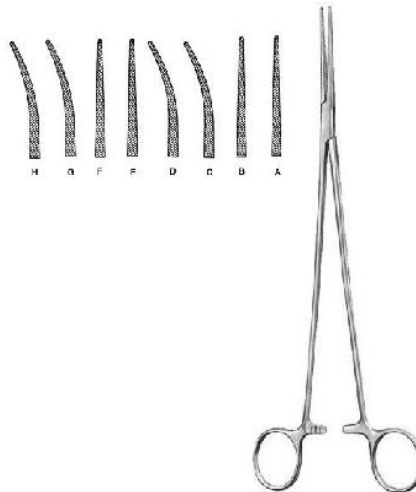

Bengolea

AN-5-636-20

Haemostatic Forceps

21.5 cm, 26 cm, 21 cm, 21.5 cm,

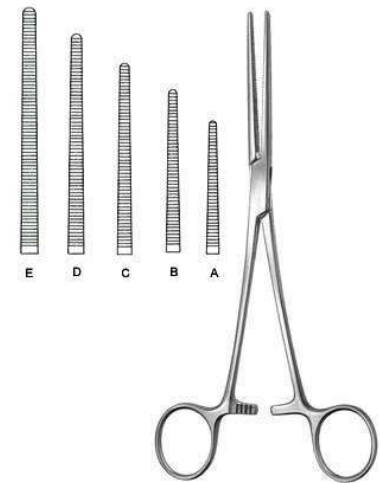

Pean (Rochester)

AN-5-637-14

Haemostatic Forceps

14.5 cm, 16.5 cm, 18.5 cm, 20.5 cm, 22.5 cm, 24.5 cm, 26 cm, 30.5 cm, 14 cm, 16 cm,



Haemostatic Forceps

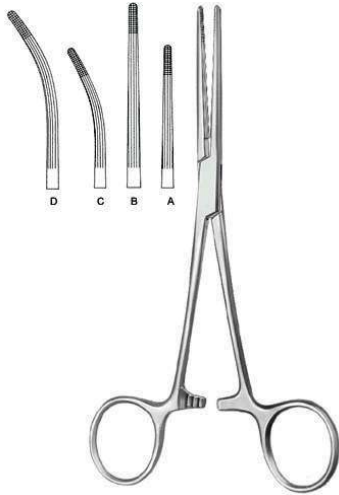

Rochester-Carmalt

AN-5-631-16

Haemostatic Forceps

17 cm, 20.5 cm, 16.5 cm, 20 cm,

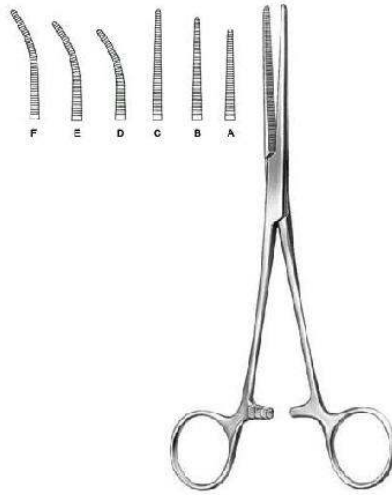

Pean

AN-5-632-13

Haemostatic Forceps

13.5 cm, 14.5 cm, 17 cm, 13 cm, 14 cm, 16.5 cm,

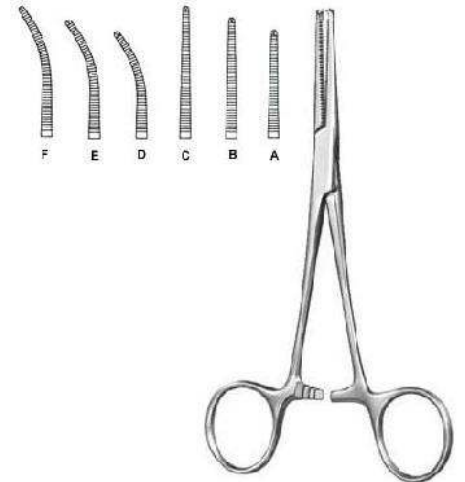

Kocher-Nippon

AN-5-633-14

Haemostatic Forceps

14.5 cm, 16.5 cm, 18.5 cm, 16 cm, 18 cm,

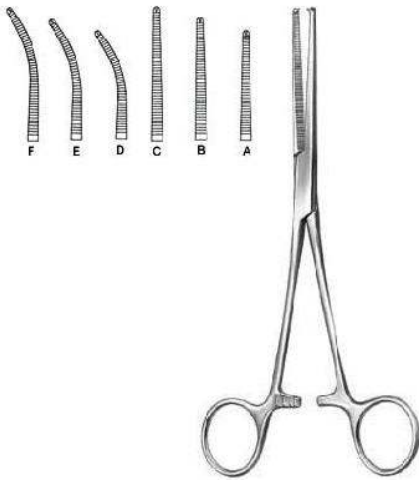

Kocher

AN-5-635-13

Haemostatic Forceps

13 cm, 14 cm, 16 cm,

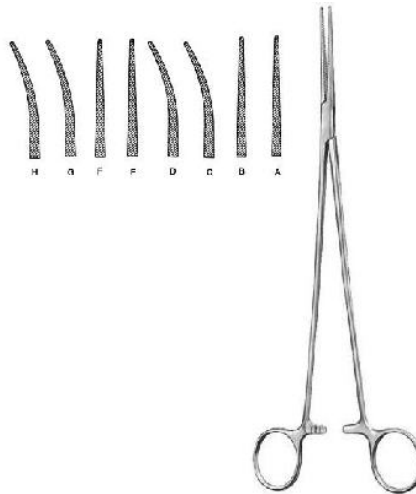

Bengolea

AN-5-636-20

Haemostatic Forceps

21.5 cm, 26 cm, 21 cm, 21.5 cm,

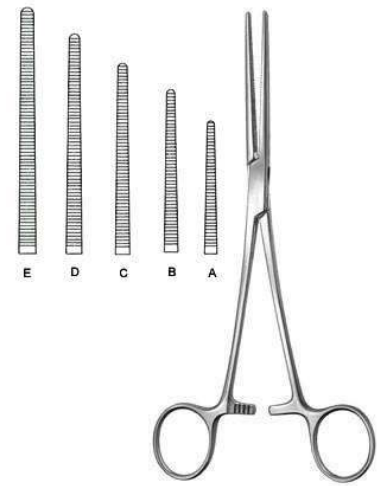

Pean (Rochester)

AN-5-637-14

Haemostatic Forceps

14.5 cm, 16.5 cm, 18.5 cm, 20.5 cm, 22.5 cm, 24.5 cm, 26 cm, 30.5 cm, 14 cm, 16 cm,



Haemostatic Forceps

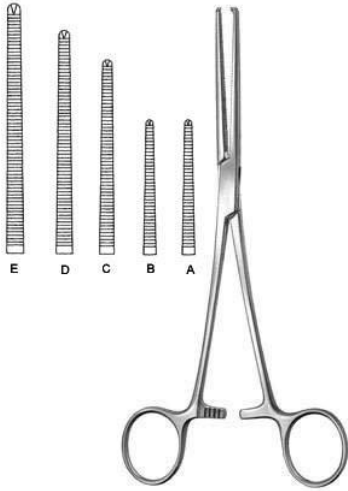

Kocher (Ochsner)
AN-5-638-14

Haemostatic Forceps
14.5 cm, 16.5 cm, 18.5 cm, 20.5 cm, 22.5 cm, 24.5 cm, 26 cm, 30.5 cm,

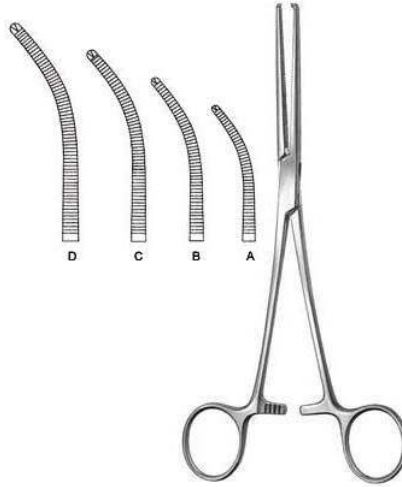

Kocher (Ochsner)
AN-5-639-14

Haemostatic Forceps
14 cm, 16 cm, 18 cm, 20 cm, 22 cm, 24 cm, 25.5 cm, 30 cm,

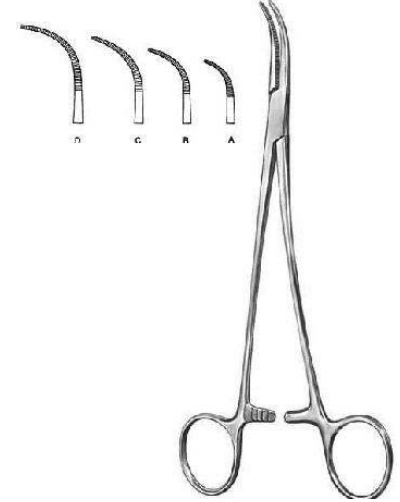

Overholt-Martin
AN-5-640-01

Dissecting and Ligature Forceps
18.5 cm Fig. 1, 20.5 cm Fig. 2, 21 cm Fig. 3, 21.5 cm Fig. 4, 24.5 cm Fig. 5,



Mixer-Baby
AN-5-641-18

Dissecting and Ligature Forceps
18.5 cm,



Adson-Baby
AN-5-642-14

Dissecting and Ligature Forceps
14.5 cm, 18 cm,



Heiss
AN-5-643-20

Dissecting and Ligature Forceps
21 cm, 20.5 cm, 20 cm,



Haemostatic Forceps



Overholt-Mixer
AN-5-644-21

Dissecting and Ligature Forceps
21.5 cm,

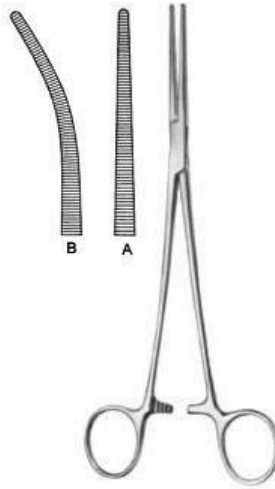

Roberts

AN-5-645-22

Dissecting and Ligature Forceps
22.5 cm, 21.5 cm,

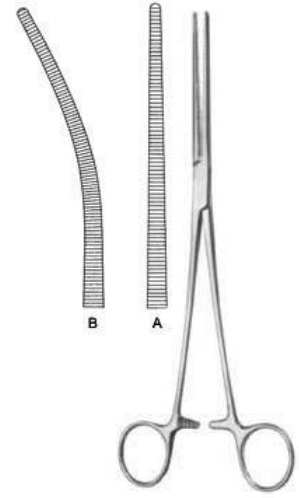

Sarot

AN-5-646-24

Dissecting and Ligature Forceps
25 cm, 24.5 cm,

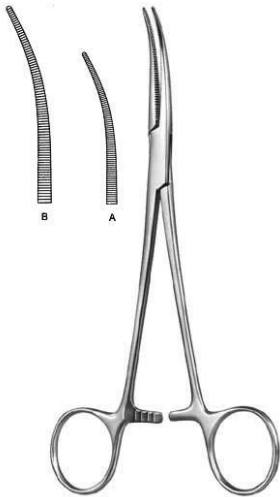

Crafoord

AN-5-647-18

Dissecting and Ligature Forceps
18 cm, 24.5 cm,

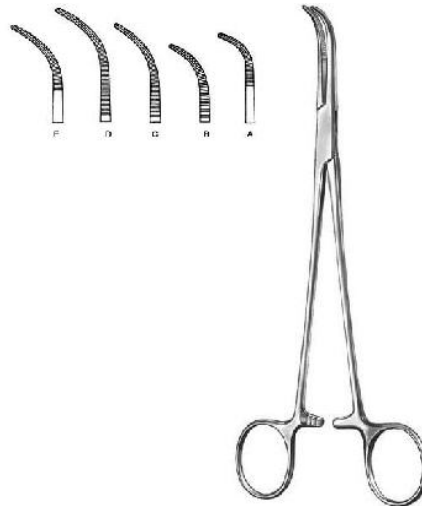

Overholt-Geissendorfer

AN-5-648-01

Dissecting and Ligature Forceps
20.5 cm Fig. 1, 20 cm Fig. 2, 21.5 cm Fig. 3, 22 cm Fig. 4, 21.5 cm Fig. 5, 22 cm Fig. 6, 27 cm Fig. 1, 26.5 cm Fig. 2, 27.5 cm Fig. 3, 28 cm Fig. 4,

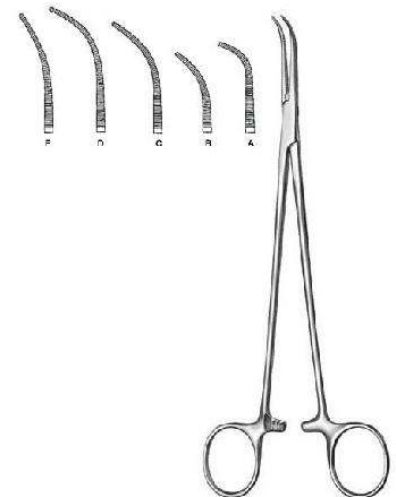

Overholt-Fino

AN-5-649-00

Dissecting and Ligature Forceps
21.5 cm, 21 cm, 22 cm, 23 cm, 22.5 cm,



Haemostatic Forceps

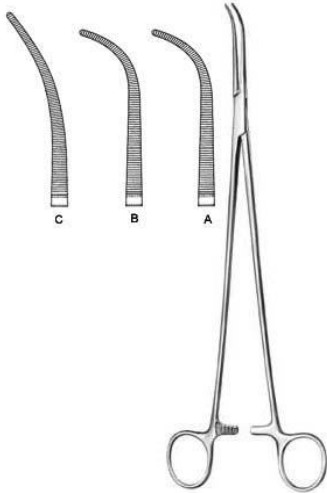

Overholt
AN-5-650-00
Dissecting and Ligature Forceps
29.5 cm, 30 cm,



Overholt-Mini
AN-5-651-01
Dissecting and Ligature Forceps
15 cm, 20 cm,

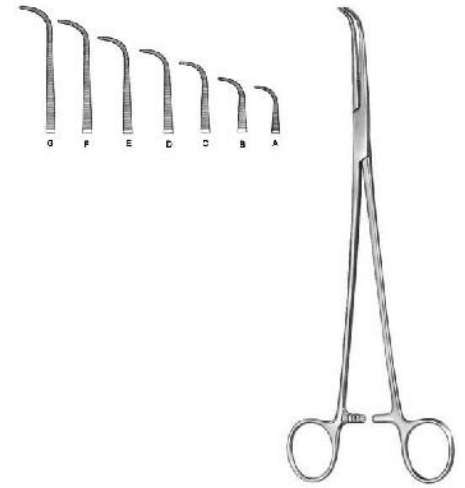

Gemini
AN-5-652-13
Dissecting and Ligature Forceps
13 cm, 16 cm, 18 cm, 21 cm, 23 cm, 25 cm, 28 cm,

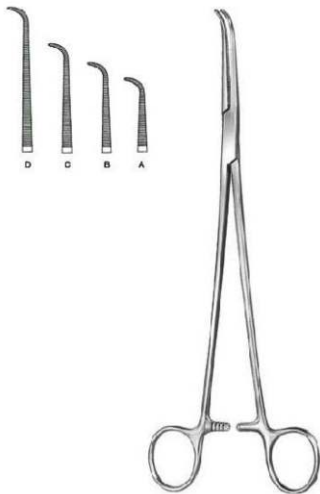

Mini-Gemini
AN-5-653-18
Dissecting and Ligature Forceps
18 cm, 22.5 cm, 25 cm, 28.5 cm,

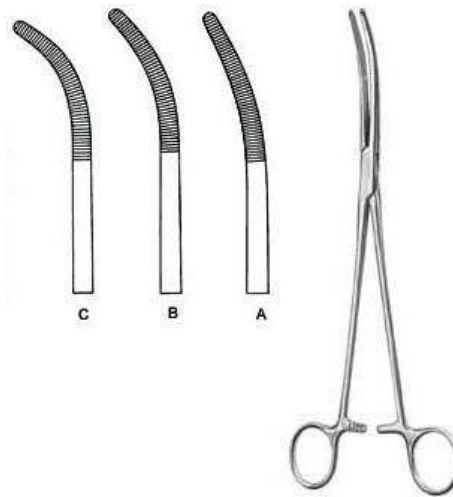

Rumel
AN-5-654-01
Dissecting and Ligature Forceps
24 cm Fig. 1, 23.5 cm Fig. 2, 23 cm Fig. 3, 24 cm Fig. 4, 23.5 cm Fig. 5,

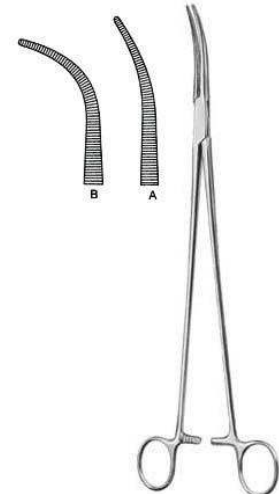

Zenker
AN-5-655-01
Dissecting and Ligature Forceps
29.5 cm, 28.5 cm,



Haemostatic Forceps



Mixer-Baby
AN-5-656-14
Dissecting and Ligature Forceps
13.5 cm,



Mixer
AN-5-657-15
Dissecting and Ligature Forceps
16 cm, 18 cm,



Mixer-O Shaugnessy
AN-5-658-19
Dissecting and Ligature Forceps
18 cm,



Mixer
AN-5-659-22
Dissecting and Ligature Forceps
22.5 cm,



Mixer
AN-5-660-23
Dissecting and Ligature Forceps
23 cm,



Wickstrom
AN-5-661-21
Dissecting and Ligature Forceps
21 cm, 24.5 cm,



Haemostatic Forceps

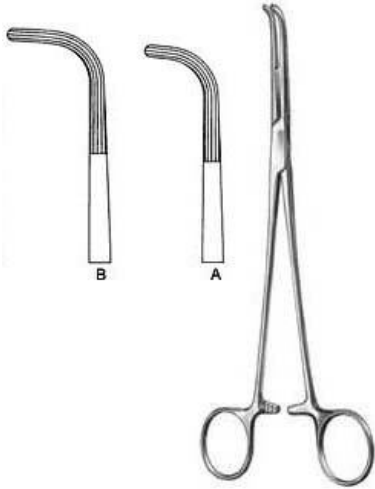

Mixer
AN-5-662-22
Dissecting and Ligature Forceps
22.5 cm, 26 cm, 28 cm,



Mc Quigg-Mixer
AN-5-663-22
Dissecting and Ligature Forceps
23.5 cm,



Lower
AN-5-664-18
Dissecting and Ligature Forceps
18.5 cm,



Lahey
AN-5-665-19
Bile Duct Clamp
19.5 cm, 22.5 cm,



Finochietto
AN-5-666-24
Dissecting and Ligature Forceps
24 cm,



Uro-Tangential
AN-5-667-01
Tangential Forceps
25 cm, 27 cm,



Haemostatic Forceps

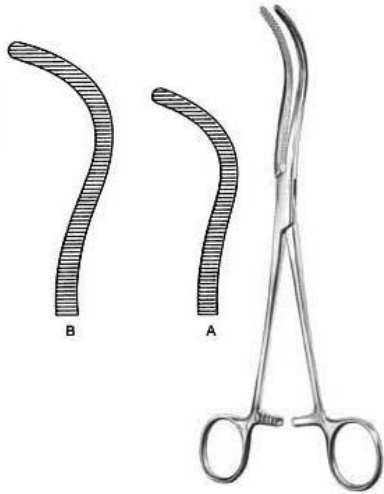

Guyon
AN-5-668-20
Kidney Pedicle Clamp
23 cm, 24 cm,



Guyon
AN-5-669-23
Kidney Pedicle Clamp
19.5 cm, 21.5 cm, 24 cm,



Desjardins
AN-5-670-21
Bile Duct Clamp
21 cm,

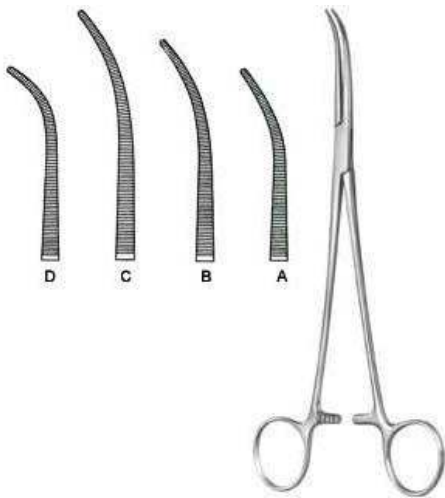

Kelly
AN-5-671-19
Dissecting and Ligature Forceps
19.5 cm Fig. 1, 22.5 cm Fig. 1, 24.5 cm Fig. 1,
19 cm Fig. 2, 22 cm Fig. 2, 24 cm Fig. 2, 18.5 cm Fig. 3,
21.5 cm Fig. 3, 23.5 cm Fig. 3,



Lawrence
AN-5-672-28
Dissecting and Ligature Forceps
28 cm,



Meeker
AN-5-673-28
Dissecting and Ligature Forceps
28 cm,



ANARIF CO OÜ
Trader & Supplier

SURGICAL INSTRUMENTS

Haemostatic Forceps



Negus

AN-5-674-19

Haemostatic Forceps

19.5 cm Fig. 1, 20 cm Fig. 2,



Towel & Tubing Clamps



Schaedel
AN-5-701-09
Towel Clamp sharp
9 cm,



Jones
AN-5-702-05
Towel Clamp sharp
5.5 cm, 8.5 cm,



Jones-Martin
AN-5-703-09
Towel Clamp sharp
8.5 cm,



Backhaus
AN-5-704-11
Towel Clamp
11.5 cm, 13 cm,



Backhaus
AN-5-705-11
Towel Clamp
11.5 cm,



Backhaus
AN-5-706-08
Towel Clamp
9 cm, 11.5 cm, 13 cm, 16 cm,



Towel & Tubing Clamps

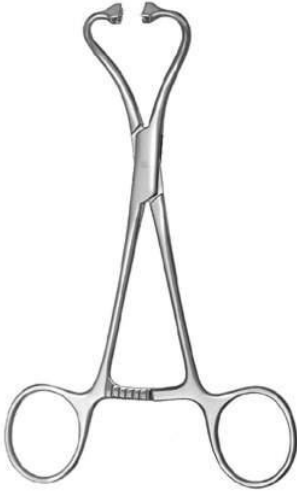

Peers-Bertram modif.

AN-5-707-15

Towel Clamp wide jaw for tube fixation
15.5 cm,



R?der

AN-5-708-13

Towel Clamp
13.5 cm,

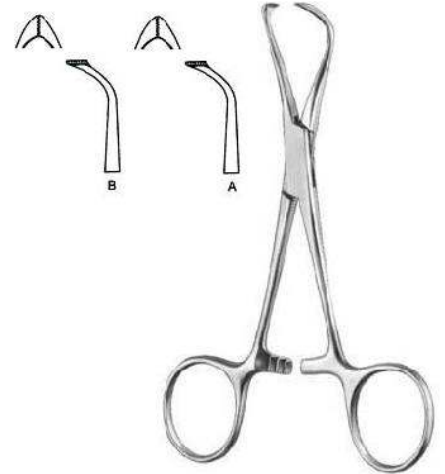

Lorna

AN-5-709-10

Towel Clamp fine serrated, wide jaw
9.5 cm, 13 cm,



Bernhard

AN-5-710-16

Towel Clamp
16.5 cm,

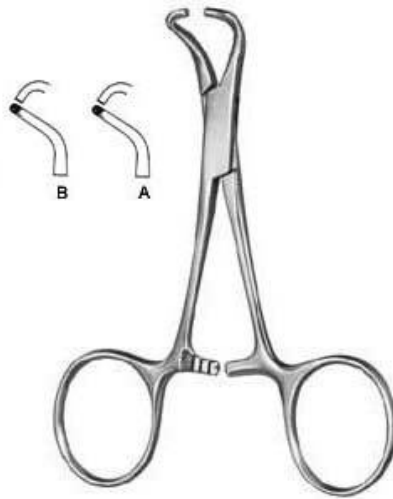

Tohoku

AN-5-711-10

Towel Clamp
10.5 cm blunt, 13.5 cm blunt, 14.5 cm,

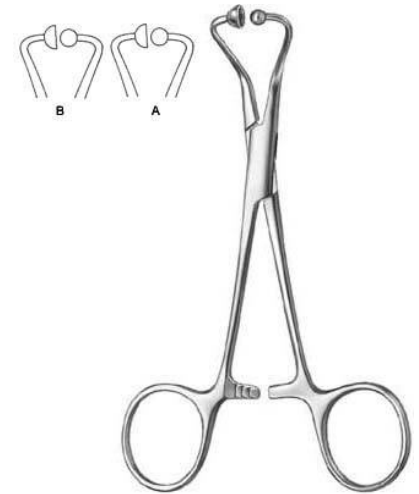

AN-5-712-11

Towel Clamp for paper clothes
11.5 cm, 14 cm,



Towel & Tubing Clamps



Lane
AN-5-713-20
Towel Clamp
19.5 cm,



AN-5-714-06
Tube Holder for fixation of six tubes



AN-5-715-14
Tubing Clamp extra long ratchet
14 cm,



AN-5-716-16
Tubing Clamp
16.5 cm,

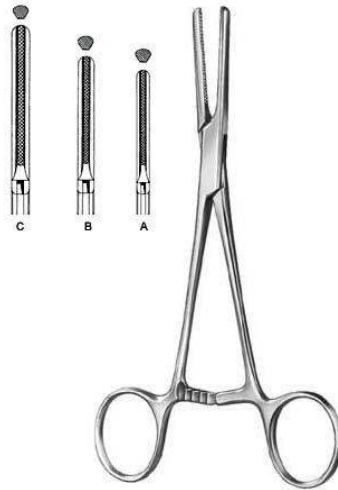

AN-5-717-15
Tubing Clamp
15.5 cm, 19 cm, 20.5 cm,

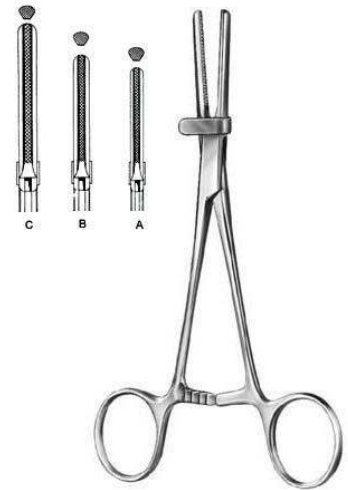

AN-5-718-15
Tubing Clamp with safety guard
15.5 cm, 19 cm, 20.5 cm,



Dressing & Sponge Forceps

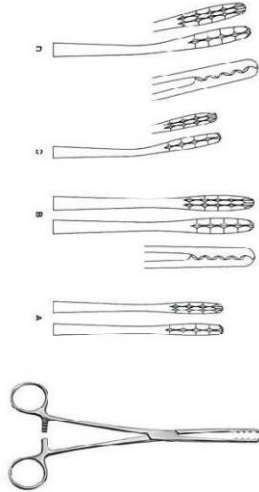

Ulrich
AN-5-801-22
Dressing Forceps
22.5 cm, 26.5 cm,

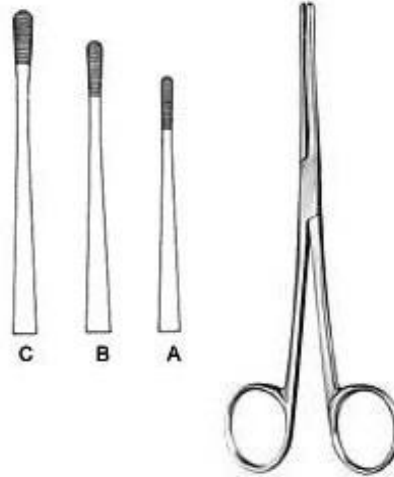

Lister
AN-5-802-13
Sinus Forceps
13 cm, 16 cm, 18 cm,



Martin
AN-5-803-17
Dressing Forceps
17.5 cm, 17 cm,

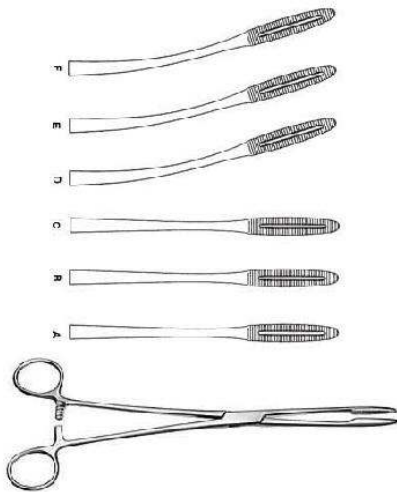

Gross-Maier
AN-5-804-20
Dressing Forceps
20.5 cm, 22 cm, 26.5 cm, 20 cm, 21.5 cm, 26 cm,



AN-5-805-40
Tunneling Forceps
39.5 cm,



Collin
AN-5-806-25
Dressing Forceps
25.5 cm,



Towel & Tubing Clamps



Lane
AN-5-713-20
Towel Clamp
19.5 cm,



AN-5-714-06
Tube Holder for fixation of six tubes



AN-5-715-14
Tubing Clamp extra long ratchet
14 cm,



AN-5-716-16
Tubing Clamp
16.5 cm,

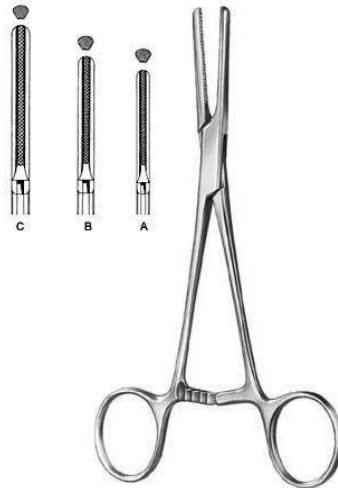

AN-5-717-15
Tubing Clamp
15.5 cm, 19 cm, 20.5 cm,

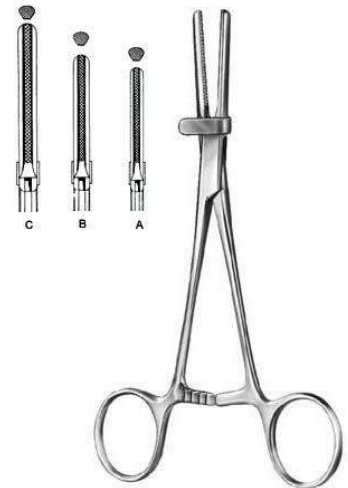

AN-5-718-15
Tubing Clamp with safety guard
15.5 cm, 19 cm, 20.5 cm,



Dressing & Sponge Forceps

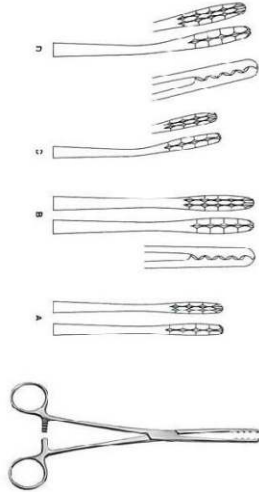

Ulrich
AN-5-801-22
Dressing Forceps
22.5 cm, 26.5 cm,

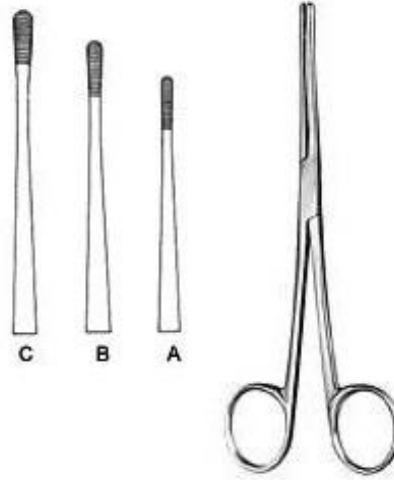

Lister
AN-5-802-13
Sinus Forceps
13 cm, 16 cm, 18 cm,



Martin
AN-5-803-17
Dressing Forceps
17.5 cm, 17 cm,

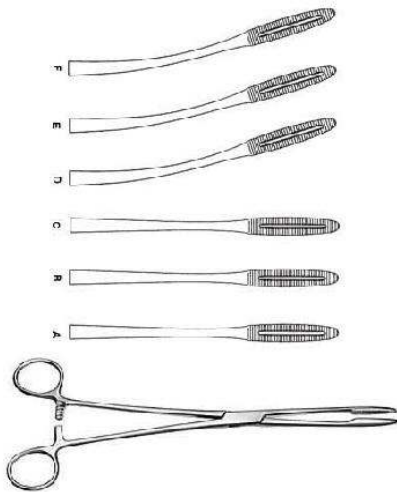

Gross-Maier
AN-5-804-20
Dressing Forceps
20.5 cm, 22 cm, 26.5 cm, 20 cm, 21.5 cm, 26 cm,



AN-5-805-40
Tunneling Forceps
39.5 cm,



Collin
AN-5-806-25
Dressing Forceps
25.5 cm,



Dressing & Sponge Forceps

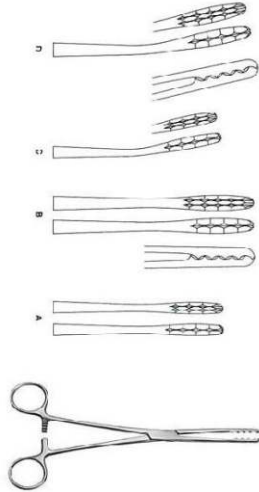

Ulrich
AN-5-801-22
Dressing Forceps
22.5 cm, 26.5 cm,

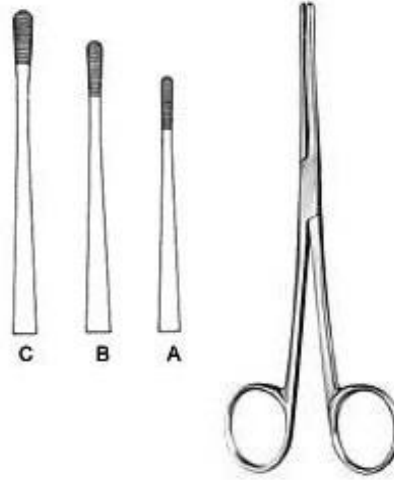

Lister
AN-5-802-13
Sinus Forceps
13 cm, 16 cm, 18 cm,



Martin
AN-5-803-17
Dressing Forceps
17.5 cm, 17 cm,

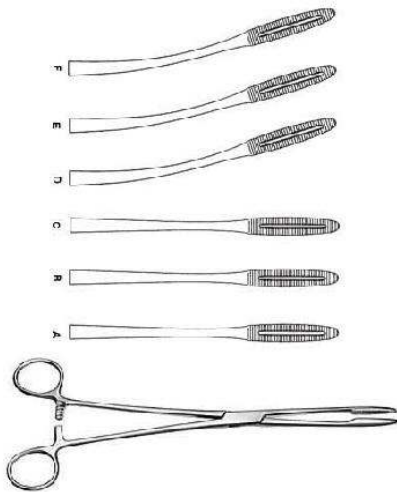

Gross-Maier
AN-5-804-20
Dressing Forceps
20.5 cm, 22 cm, 26.5 cm, 20 cm, 21.5 cm, 26 cm,



Tunneling Forceps
AN-5-805-40
39.5 cm,



Collin
AN-5-806-25
Dressing Forceps
25.5 cm,



Dressing & Sponge Forceps



Cheron
AN-5-807-25
Dressing Forceps
23.5 cm,



Bozemann
AN-5-808-26
Sponge Forceps
26 cm,

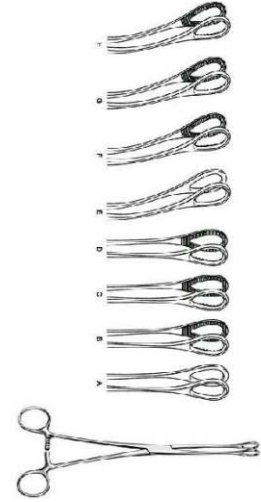

Foerster
AN-5-809-25
Sponge Forceps
25 cm, 18 cm, 20.5 cm, 24.5 cm, 17.5 cm, 20 cm, 24.5 cm,

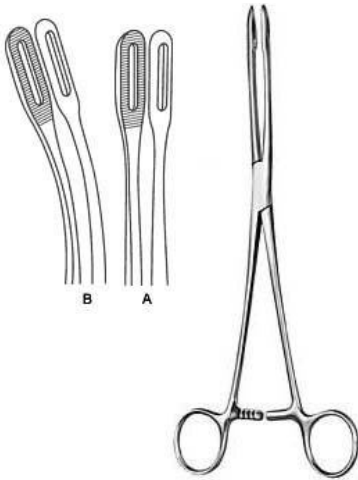

Foerster
AN-5-810-25
Sponge Forceps
25 cm, 24.5 cm,

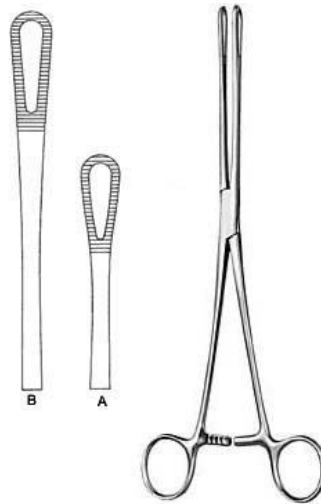

Rampley
AN-5-811-18
Sponge Forceps
18.5 cm, 24.5 cm,



Retractors



Vickers
AN-5-901-18
Skin Hooklet
18.5 cm,



Vickers
AN-5-902-01
Bone Hooklet
17 cm,



Vickers
AN-5-903-01
Tendon Hooklet
17 cm,



Vickers
AN-5-904-02
Hooklet
16 cm,

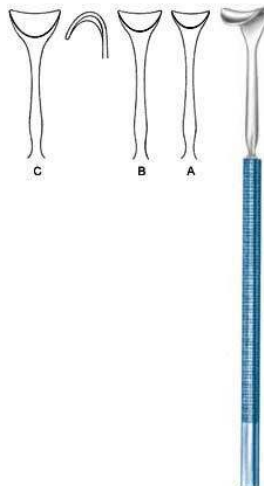

Vickers
AN-5-905-12
Saddle Hook
14 cm,



Graefe
AN-5-906-01
Micro Hooklet
15 cm,



ANARIF CO OÜ
Trader & Supplier

Retractors

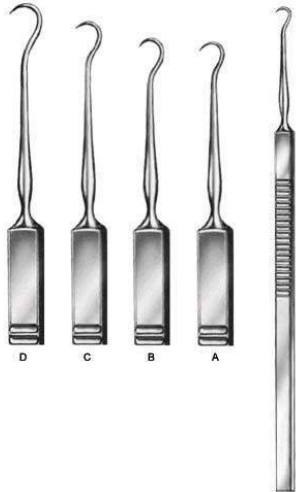

AN-5-907-01
Skin Hook
16 cm Fig. 1, 16 cm Fig. 2, 16 cm Fig. 3, 16 cm Fig. 4,



O Connor
AN-5-908-16
Skin Hook
16 cm,



Guthrie
AN-5-909-01
Skin Hook
15.5 cm,

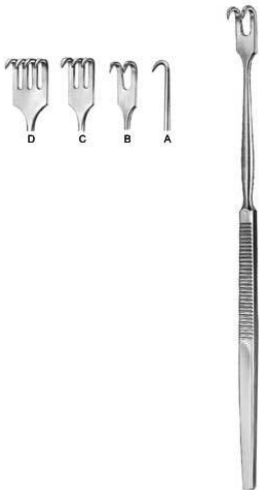

AN-5-910-01
Hooklet
16.5 cm,

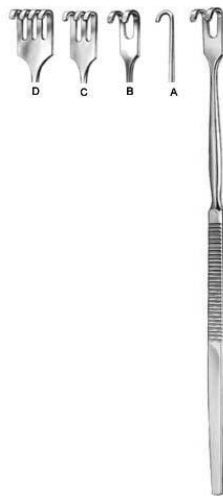

AN-5-911-01
Hooklet
16.5 cm,



AN-5-912-02
Hooklet
16 cm,



Retractors



AN-5-913-04
Hooklet
16.5 cm,



AN-5-914-12
Vessel Hook
12 cm,

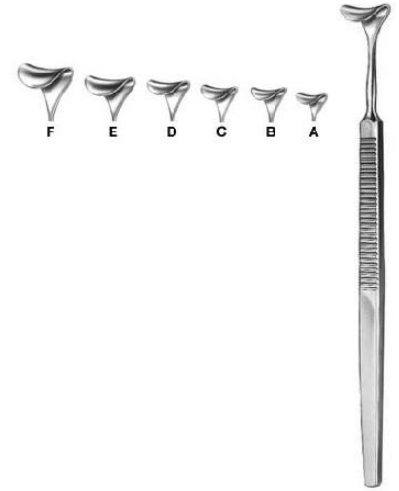

Desmarres
AN-5-915-08
Saddle Hook
16 cm 8 mm, 16 cm 10 mm, 16 cm 12 mm, 16 cm 14 mm, 16 cm 16 mm, 16 cm 18 mm,

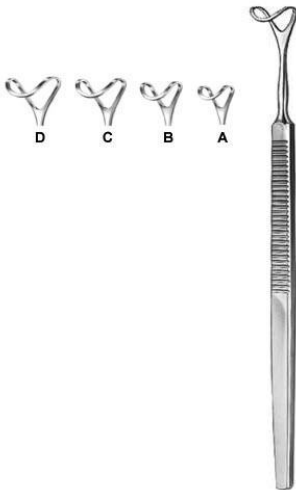

AN-5-916-12
Saddle Hook
16 cm 12 mm, 16 cm 14 mm, 16 cm 16 mm, 16 cm 18 mm,

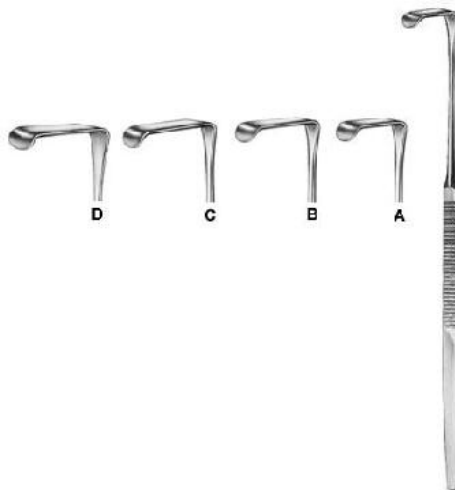

Langenbeck-Mini
AN-5-917-10
Hooklet
16 cm,



AN-5-918-16
Hooklet
16 cm 14 x 8,



Retractors



AN-5-919-01
Hooklet
16.5 cm,



AN-5-920-01
Hooklet
16.5 cm,



Meyerding
AN-5-921-01
Hooklet
17.5 cm Fig. 1, 17.5 cm Fig. 2, 17.5 cm Fig. 3, 17.5 cm Fig. 4, 17.5 cm Fig. 5, 17.5 cm Fig. 6,



Senn-Green
AN-5-922-01
Hooklet
15 cm Fig. 1, 15 cm Fig. 2,



Ragnell-Davis
AN-5-923-14
Hooklet
14 cm,

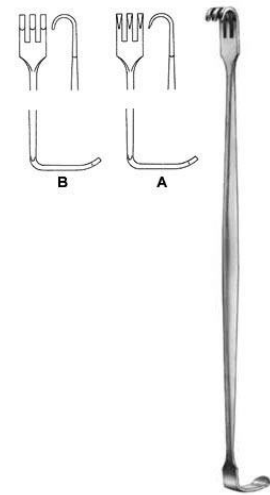

Senn-Miller
AN-5-924-16
Hooklet
16 cm,



Retractors



Cushing
AN-5-925-20
Retractor
20.5 cm,

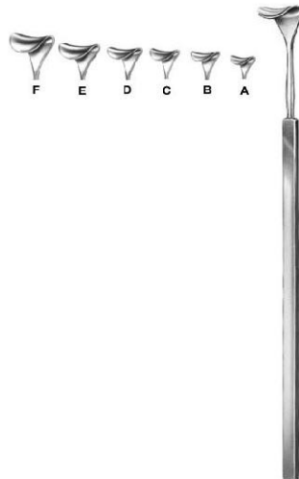

Cushing
AN-5-926-08
Saddle Hook
20.5 cm 8 mm wide, 20.5 cm 10 mm wide, 20.5 cm 12 mm wide, 20.5 cm 14 mm wide, 20.5 cm 16 mm wide, 20.5 cm 18 mm wide,

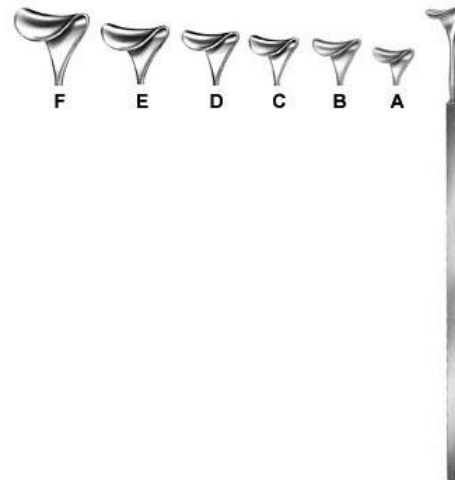

Cushing
AN-5-927-08
Saddle Hook 8 mm to 18 mm wide
24 cm,



Brom
AN-5-928-01
Vein Hook
19.5 cm,



Strandell-Stille
AN-5-929-01
Hooklet
19 cm Fig. 1, 19 cm Fig. 2,



Klapp
AN-5-930-01
Retractor 12 x 6, 12 x 11, 15 x 11
17.5 cm,



Retractors



Cushing
AN-5-925-20
Retractor
20.5 cm,



Cushing
AN-5-926-08
Saddle Hook
20.5 cm 8 mm wide, 20.5 cm 10 mm wide, 20.5 cm 12 mm wide, 20.5 cm 14 mm wide, 20.5 cm 16 mm wide, 20.5 cm 18 mm wide,

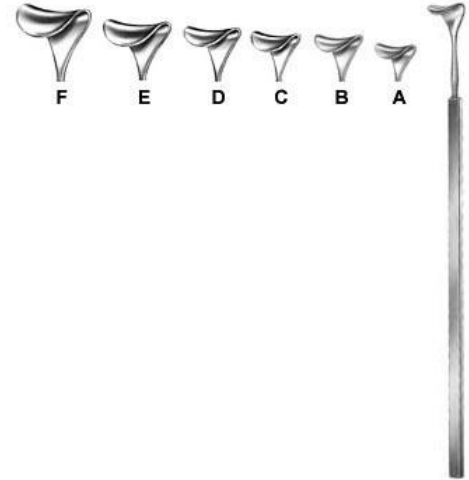

Cushing
AN-5-927-08
Saddle Hook 8 mm to 18 mm wide
24 cm,



Brom
AN-5-928-01
Vein Hook
19.5 cm,



Strandell-Stille
AN-5-929-01
Hooklet
19 cm Fig. 1, 19 cm Fig. 2,



Klapp
AN-5-930-01
Retractor 12 x 6, 12 x 11, 15 x 11
17.5 cm,



Retractors



AN-5-931-04
Hooklet
16.5 cm,

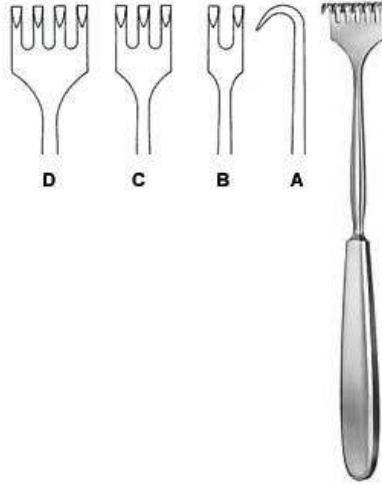

Volkmann
AN-5-932-01
Retractor
21.5 cm,

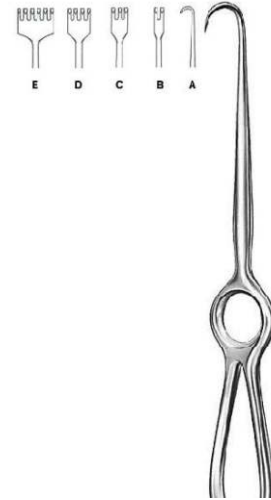

Volkmann
AN-5-933-01
Retractor
22 cm, 21.5 cm,



Kocher
AN-5-934-01
Retractor
22 cm,

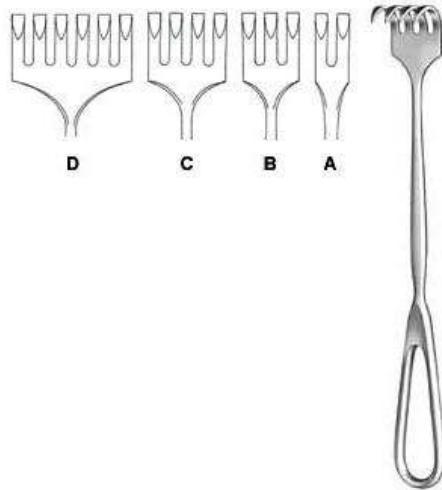

Martin
AN-5-935-02
Retractor
22.5 cm,

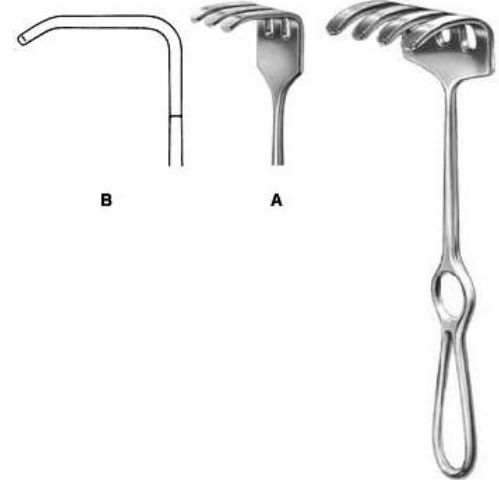

Ollier
AN-5-936-03
Retractor
23 cm 36 x 30, 23 cm 36 x 60,



Retractors

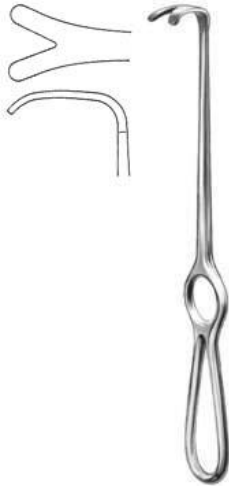

Wassmund
AN-5-937-02
Retractor
20.5 cm 33 x 21,

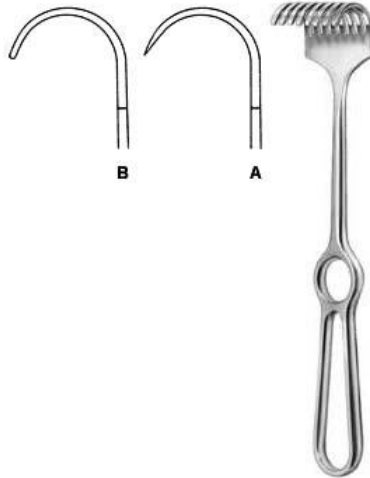

Korte
AN-5-938-08
Retractor
24.5 cm 40 x 30,

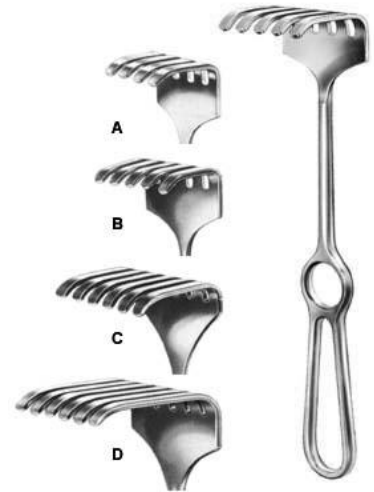

Israel
AN-5-939-04
Retractor
25.5 cm,

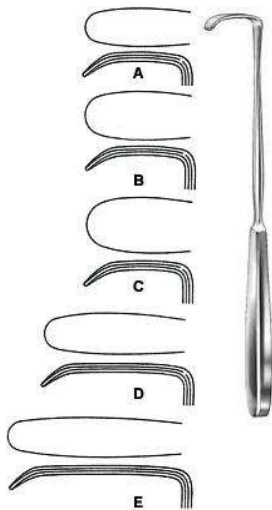

Langenbeck
AN-5-940-01
Retractor
22.5 cm 30 x 11 mm, 22.5 cm 30 x 14 mm, 22.5 cm 30 x 16 mm, 22.5 cm 40 x 11 mm, 22.5 cm 50 x 11 mm,

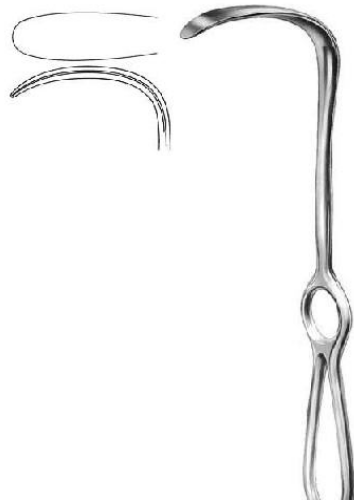

Langenbeck
AN-5-942-21
Retractor
21 cm 65 x 20 mm,



Langenbeck
AN-5-943-21
Retractor
22.5 cm 85 x 15 mm,



Retractors



Lahey
AN-5-944-19
Retractor
19.5 cm 36 x 19 mm,



Little
AN-5-945-20
Retractor
20 cm 13 x 15 mm,

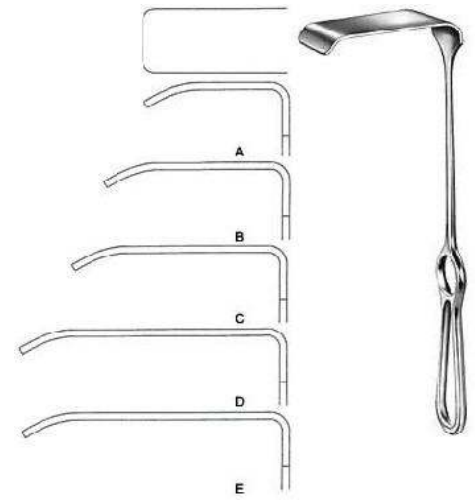

Kocher
AN-5-946-18
Retractor
23 cm 43 x 18 mm, 23 cm 53 x 20 mm, 23 cm
63 x 25 mm, 23 cm 77 x 30 mm, 23 cm 78 x
40 mm,

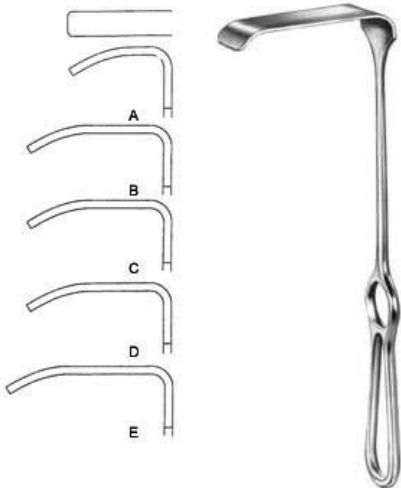

Kocher-Langenbeck
AN-5-947-01
Retractor
21.5 cm 25 x 6 mm, 21.5 cm 35 x 8 mm, 21.5
cm 35 x 11 mm, 21.5 cm 35 x 15 mm, 21.5 cm
40 x 11 mm, 21.5 cm 55 x 11 mm, 21.5 cm 70
x 14 mm, 21.5 cm 80 x 12 mm,

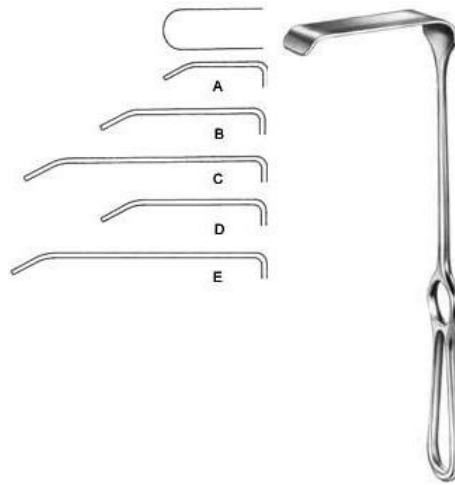

Kocher-Langenbeck
AN-5-948-01
Retractor
21.5 cm 25 x 10 mm, 21.5 cm 40 x 13
mm, 21.5 cm 60 x 13 mm, 21.5 cm 40 x 18
mm, 21.5 cm 60 x 18 mm, 21.5 cm 85 x 18
mm, 21.5 cm 60 x 25 mm, 21.5 cm 85 x 25
mm,

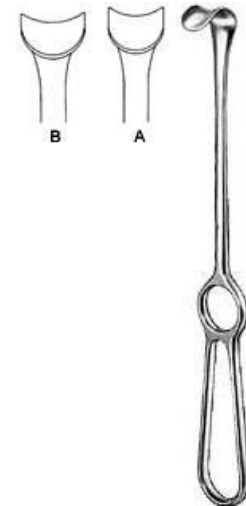

Kocher
AN-5-949-01
Retractor
21.5 cm 22 x 12 mm, 21.5 cm 24 x 14 mm,



Retractors

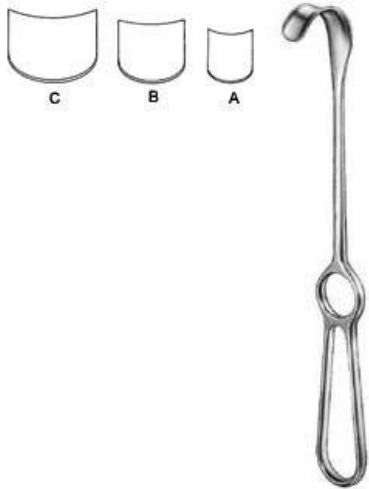

Kocher
AN-5-950-01
Retractor
22 cm 42 x 10 mm, 22 cm 42 x 15 mm, 22 cm 43 x 20 mm,

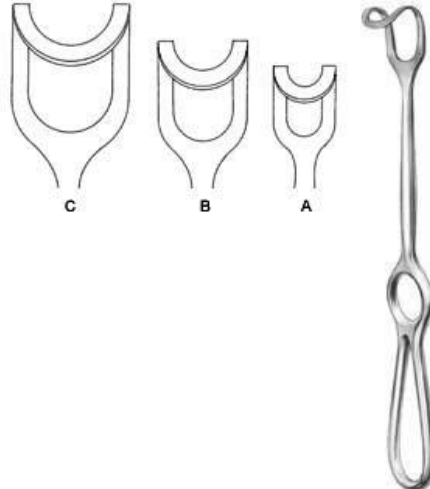

Middeldorpf
AN-5-951-01
Retractor
21.5 cm 18 x 17 mm, 23 cm 25 x 22 mm, 24.5 cm 30 x 31 mm,



Doyen-Stillle
AN-5-952-01
Retractor
26 cm 97 x 29 mm, 26 cm 101 x 31 mm, 26 cm 127 x 52 mm,



Hosel
AN-5-953-01
Retractor
26 cm 63 x 21 mm, 26 cm 83 x 30 mm, 26 cm 103 x 30 mm, 26 cm 120 x 30 mm, 26 cm 140 x 30 mm, 26 cm 140 x 40 mm,

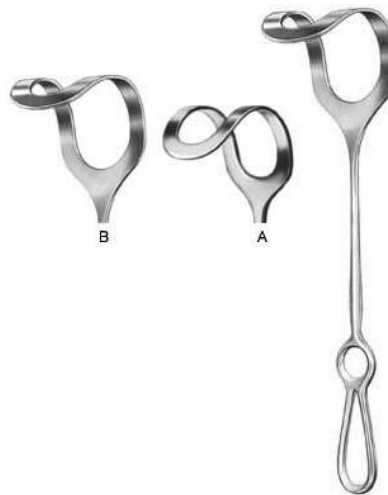

Middeldorpf
AN-5-954-01
Retractor
27 cm 48 x 45 mm, 27 cm 52 x 50 mm, 27 cm 60 x 70 mm,

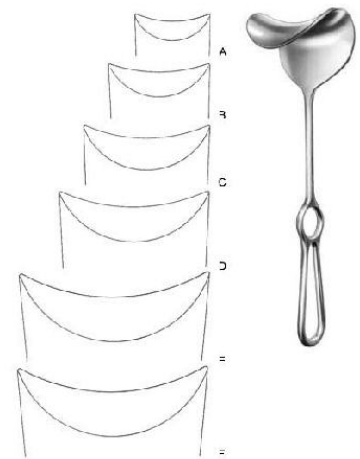

Fritsch
AN-5-955-00
Retractor
23.5 cm 37 x 31 mm, 24 cm 38 x 40 mm, 25 cm 43 x 51 mm, 25 cm 49 x 61 mm, 25.5 cm 48 x 75 mm, 25.5 cm 65 x 85 mm,



Retractors



AN-5-956-22
Retractor
24 cm 48 x 88 mm,



Kocher
AN-5-957-22
Retractor
24 cm 73 x 25 mm,



Kocher
AN-5-958-01
Retractor
25 cm 80 x 45 mm, 25 cm 80 x 55 mm, 25 cm
80 x 65 mm,



AN-5-959-01
Retractor
26 cm 110 x 27 mm,

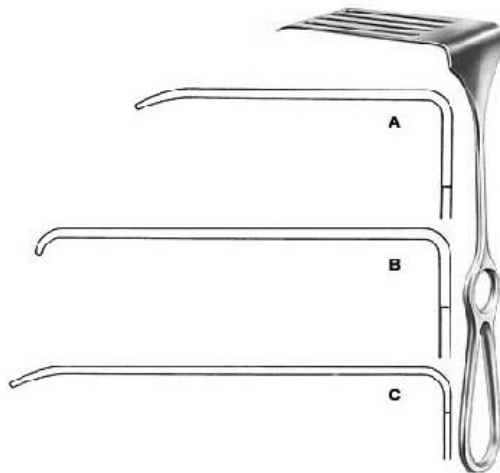

Coryllos
AN-5-960-01
Retractor
24 cm 85 x 22 mm, 24 cm 108 x 43 mm, 24 cm
119 x 65 mm,



Davidson
AN-5-961-01
Retractor
19 cm 80 x 54 mm, 18.5 cm 80 x 95 mm,



Retractors

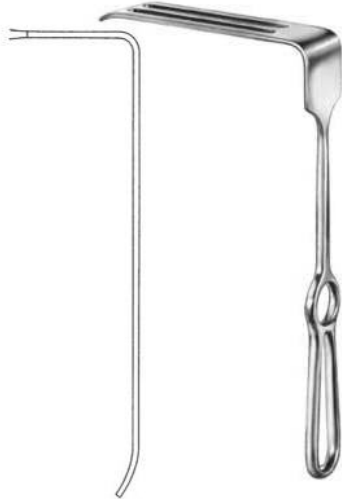

Sauerbruch
AN-5-962-25
Retractor
25.5 cm 127 x 38 mm,

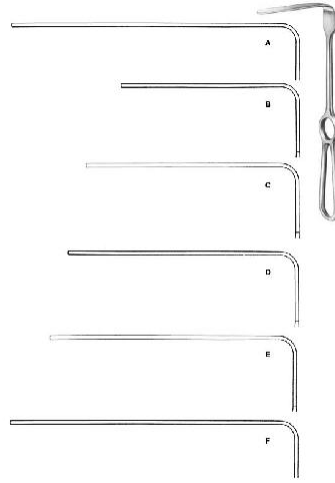

Brunner
AN-5-963-08
Retractor
25.5 cm 84 x 20 mm, 25.5 cm 104 x 25 mm, 25.5 cm 124 x 30 mm, 25.5 cm 130 x 30 mm, 25.5 cm 144 x 30 mm, 25.5 cm 160 x 30 mm, 25.5 cm 164 x 30 mm,

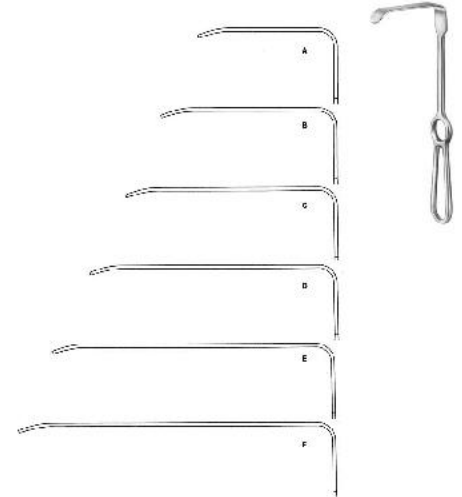

Brunner
AN-5-964-08
Retractor
25.5 cm 82 x 20 mm, 25.5 cm 102 x 20 mm, 25.5 cm 122 x 25 mm, 25.5 cm 140 x 25 mm, 25.5 cm 162 x 30 mm, 25.5 cm 182 x 30 mm,

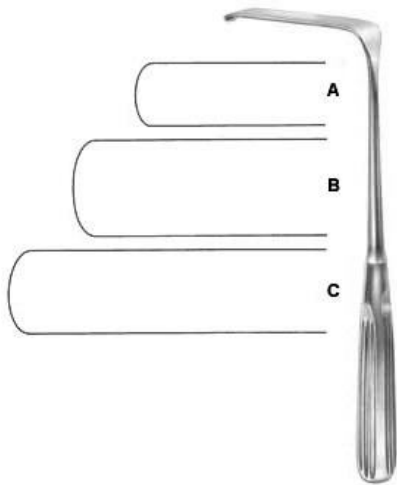

Sauerbruch
AN-5-965-01
Retractor
22.5 cm 50 x 15mm, 22.5 cm 63 x 23mm, 22.5 cm 80 x 20mm,



Deaver
AN-5-966-01
Retractor
18 cm 19mm,

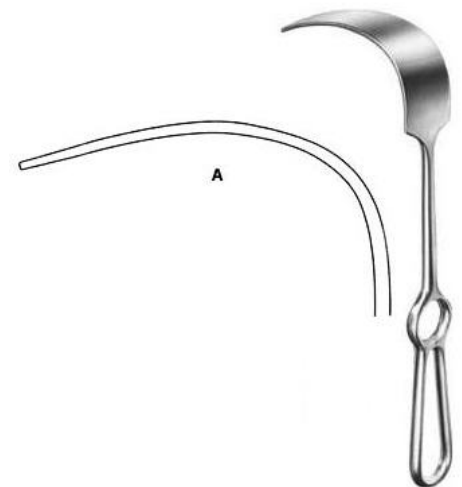

Mikulicz
AN-5-968-01
Retractor
25 cm 90 x 35mm, 25 cm 125 x 50mm, 25 cm 160 x 50mm,



Retractors



Mikulicz
AN-5-969-26
Retractor
26 cm 90 x 55mm,

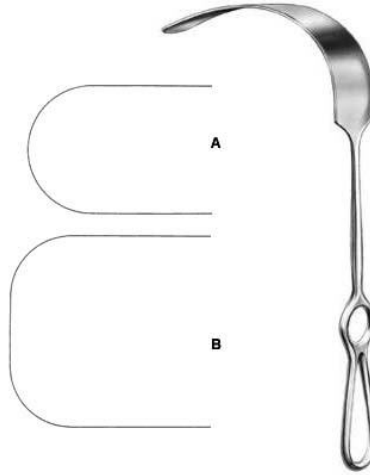

Kelly
AN-5-970-01
Retractor
27.5 cm 205 x 38mm, 27.5 cm 205 x 57mm,



Farabeuf
AN-5-971-00
Retractor
15 cm Fig. 1 = 23 x 16, 15 cm Fig. 1 = 26 x 16, 15 cm Fig. 2 = 27 x 16, 15 cm Fig. 2 = 30 x 16,

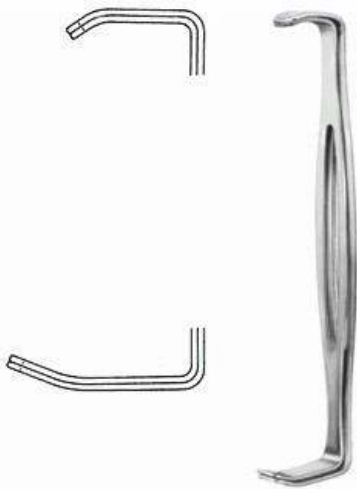

Parker-Langenbeck
AN-5-972-00
Retractor
21.5 cm Fig. 1 = 21x15mm, 21.5 cm Fig. 1 = 40x15mm, 21.5 cm Fig. 2 = 25x15mm, 21.5 cm Fig. 2 = 45x15mm,



Alm
AN-5-973-07
Wound Spreaders, self-retaining
7 cm,



Alm
AN-5-974-07
Wound Spreaders, self-retaining
7 cm,



Retractors



Gosset
AN-5-975-22
Abdominal Retractor
18.5 cm,



Balfour-Baby
AN-5-976-00
Abdominal Retractor spreading 90mm, 1
central blade 24 x 20mm
12.5 cm,



Balfour
AN-5-977-00
Abdominal Retractor spreading 180mm,
lateral blades 70 x 35mm, 1 central blade
20 cm,



Deaver
AN-5-967-04
Retractor
31.5 cm 25mm, 31.5 cm 38mm, 31.5 cm
50mm, 31.5 cm 100mm,



ANARIF CO OÜ
Trader & Supplier

SURGICAL INSTRUMENTS

Probes



AN-5-1001-11
Probe

11.5 cm, 13 cm, 14.5 cm, 16 cm, 18 cm, 20 cm, 25 cm, 30 cm,



AN-5-1002-11
Probe

11.5 cm, 13 cm, 14.5 cm, 16 cm, 18 cm, 20 cm, 25 cm, 30 cm,

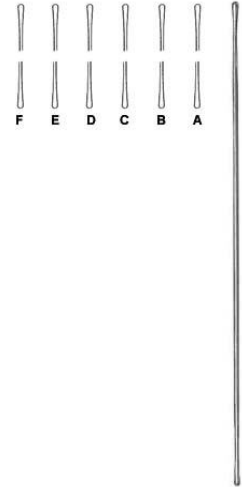

AN-5-1003-13
Probe

13 cm, 14.5 cm, 16 cm, 18 cm, 20 cm, 25 cm,



AN-5-1004-13
Probe with eye

13 cm, 14.5 cm, 16 cm,

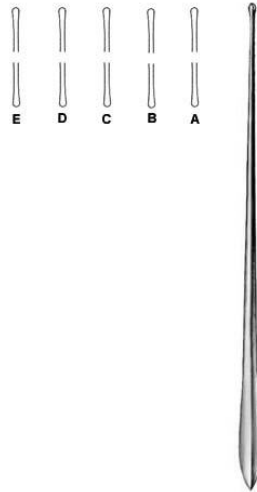

AN-5-1006-13
Myrtle Leaf Probe

13 cm, 14.5 cm, 16 cm, 18 cm, 20 cm,



AN-5-1007-13
Grooved Director

13 cm, 14 cm, 16 cm,



ANARIF CO OÜ
Trader & Supplier

SURGICAL INSTRUMENTS

Probes



AN-5-1008-13
Grooved Director
13 cm, 14.5 cm, 16 cm,



Doyen
AN-5-1009-14
Grooved Director
14.5 cm,



Nelaton
AN-5-1010-16
Grooved Director
16 cm,

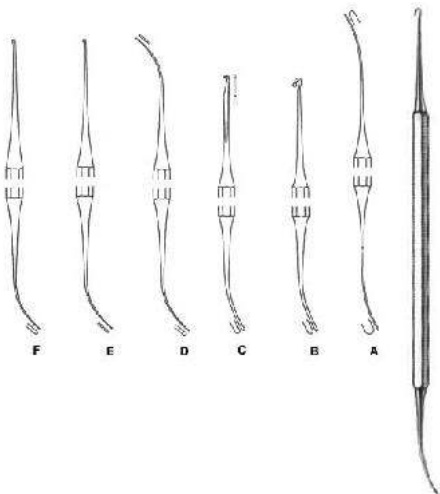

Varady
AN-5-1011-01
Phlebodissector
18 cm, 17.5 cm,



Plaster

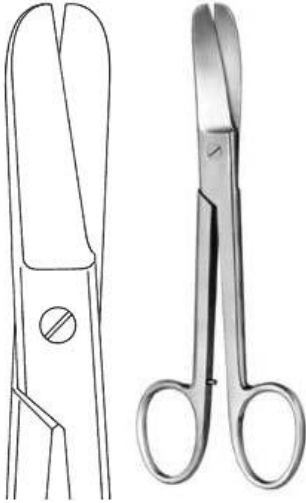

Lorenz
AN-6-101-23
Bandage Scissors heavy pattern
23 cm,



Lister
AN-6-102-14
Bandage Scissors
14.5 cm, 18.5 cm, 20 cm,



Bergmann
AN-6-103-23
Plaster Shears
23.5 cm,



Esmarch
AN-6-104-20
Plaster Shears heavy pattern, short blades
20 cm,



AN-6-105-15
Bandage Scissors black plastic ring with
autodavable
16 cm, 19 cm,



AN-6-106-18
Bandage Scissors black plastic rings
19 cm, 16 cm,



Probes

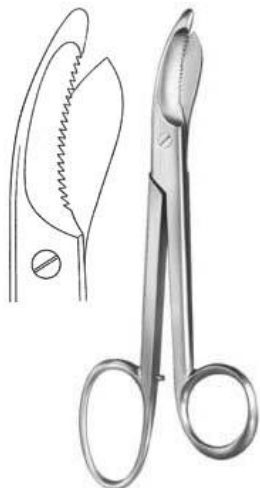

Brun's
AN-6-107-24
Plaster Scissors
24 cm,

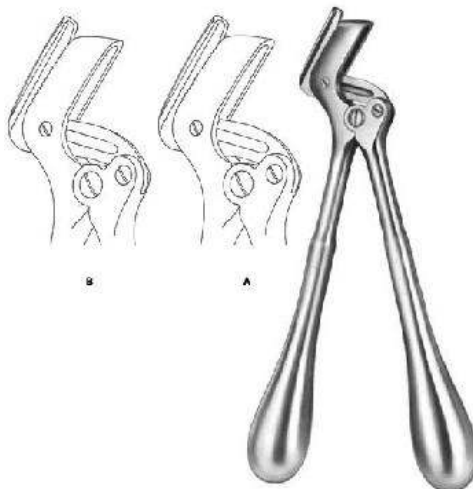

Stille-Martin
AN-6-108-23
Plaster Shears
23 cm, 27 cm, 38 cm,

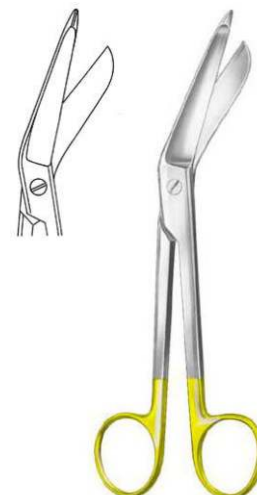

Lister
AN-6-109-18
Bandage Scissors
18 cm,

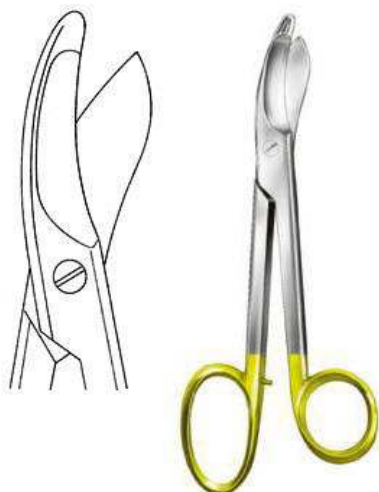

Brun's
AN-6-110-24
Plaster Scissors
24 cm,



Hopkins
AN-6-111-20
Plaster Knife with wooden handle
20 cm,



Reiner
AN-6-112-18
Plaster Knife
18 cm,



Probes



Reiner
AN-6-113-18
Plaster Knife
18 cm,



Martin
AN-6-114-21
Plaster Knife with wooden handle
21 cm,



Engel
AN-6-115-14
Plaster Saw
15.5 cm,

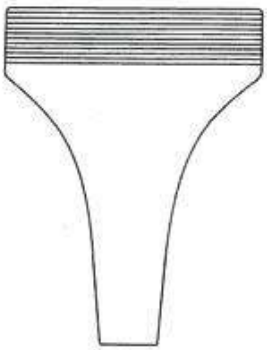

Hennig
AN-6-116-28
Plaster Spreader
28 cm,

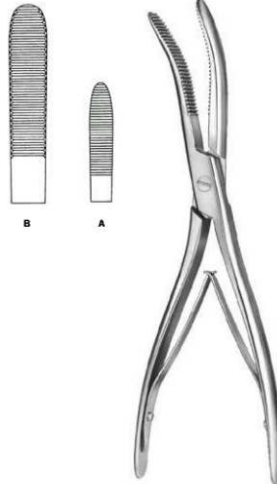

Wolff
AN-6-117-18
Plaster Breaker
18 cm, 26.5 cm,



Neurosurgery



Gigli
AN-8-101-01
Wire Saw Handle



De Martel
AN-8-102-33
Wire Saw Guide
33 cm,



Crutchfield
AN-8-103-01
Skull Traction Tong small pattern



AN-8-104-01
Skull Traction Tong large pattern
22.5 cm,



Dahlgren
AN-8-105-20
Cranial Rongeur
20 cm,



Olivecrona-Toennis
AN-8-106-14
Clip Applying Forceps



ANARIF CO OÜ
Trader & Supplier

SURGICAL INSTRUMENTS

Neurosurgery



McKenzie
AN-8-107-19
Clip Applying Forceps
18.5 cm,



Olivecrona
AN-8-108-18
Dura Dissector
18 cm,



Olivecrona
AN-8-109-19
Dura Dissector
20 cm,



Milligan
AN-8-110-21
Dura Dissector
21.5 cm,



Davis
AN-8-111-21
Dura Dissector sharp
21.5 cm,



AN-8-112-22
Dura Dissector
22 cm,



ANARIF CO OÜ
Trader & Supplier

SURGICAL INSTRUMENTS

Neurosurgery



Davis
AN-8-113-24
Dura Dissector
24.5 cm,



Love
AN-8-114-19
Nerve Root Retractor
21.5 cm, 18 cm, 11 cm,



Olivecrona
AN-8-115-18
Brain Spatula
18 cm,



Scoville
AN-8-116-23
Nerve Root Retractor 8mm
23.5 cm,



Holsher
AN-8-117-24
Nerve Root Retractor 8mm
23.5 cm,



Scoville
AN-8-118-19
Nerve Root Retractor 7mm
16.5 cm,



Neurosurgery



Groningen
AN-8-119-26
Nerve Hook
26.5 cm,



Groningen
AN-8-120-26
Nerve Hook
26.5 cm,



Cushing
AN-8-121-19
Nerve Hook blunt
19 cm,28 cm,

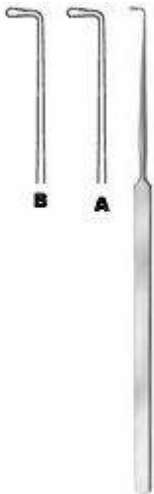

Cushing
AN-8-122-19
Nerve Hook
19.5 cm,28 cm,



Smithwick
AN-8-123-17
Nerve Hook
17 cm,21 cm,



Halle
AN-8-125-20
Dura Knife
20 cm,



Neurosurgery



Adson
AN-8-126-20
Dura Hook
20 cm,



Graham
AN-8-127-16
Dura Hook blunt
16.5 cm,



Sachs
AN-8-128-18
Dura Hook sharp
18 cm,



Toennis
AN-8-129-15
Dura Hook sharp
14.5 cm,



Frazier
AN-8-130-13
Dura Hook sharp
13 cm, 18 cm,



Krayenbuhl
AN-8-131-01
Nerve and Vessel Hooklet
18.5 cm Fig. 1, 18.5 cm Fig. 2,



Neurosurgery



Cloward
AN-8-132-16
Lamina Spreader
16 cm,

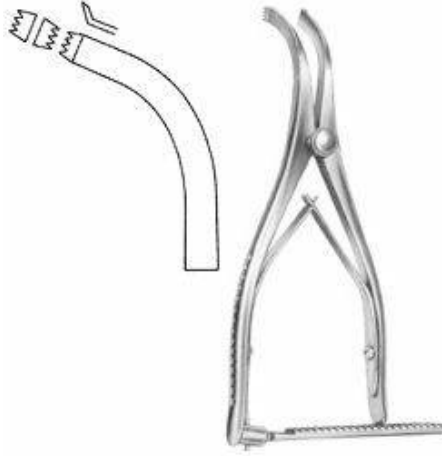

Inge
AN-8-133-17
Lamina Spreader
16 cm,

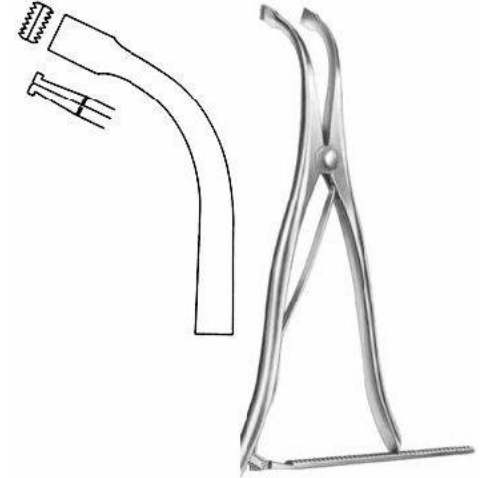

Inge
AN-8-134-27
Lamina Spreader
25.5 cm,

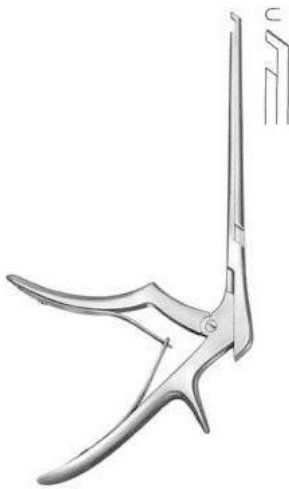

Ferris-Smith Kerrison
AN-8-135-03
Laminaectomy Punch 3mm downwards cutting
40 degree shaft length 180 mm

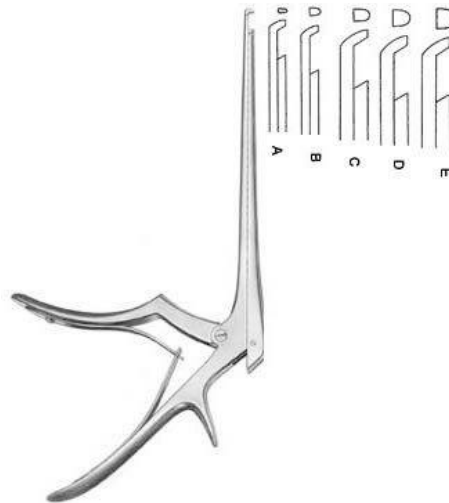

Ferris-Smith Kerrison
AN-8-138-01
Laminaectomy Punch upwards cutting shaft
length 180 mm
1 mm, 2 mm, 3 mm, 4 mm, 5 mm, 6 mm,

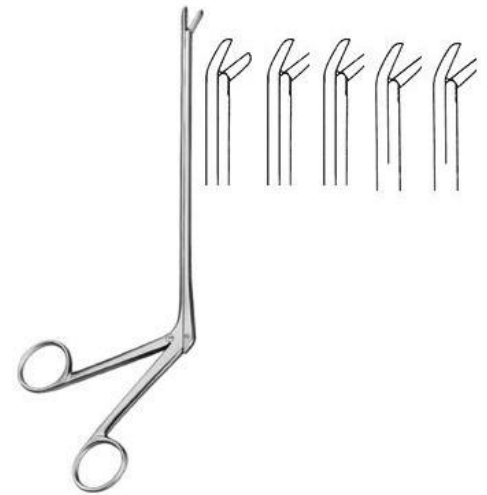

Cushing
AN-8-139-01
Laminaectomy Rongeur jaw 2 x 10 to 4 x 10
mm straight shaft length 180 mm



Neurosurgery

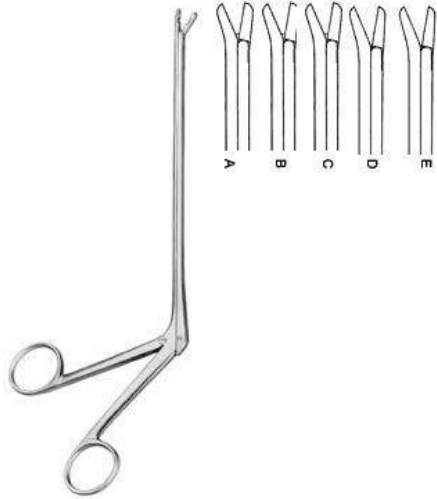

Cushing

AN-8-140-01

Laminectomy Rongeur jaw 2 x 10 to 4 x 10 mm upwards 45 degree shaft length 120 mm

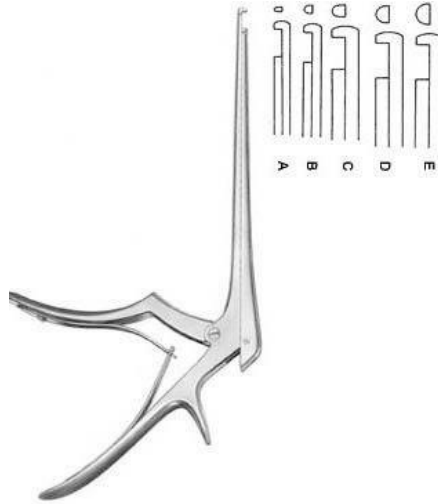

Ferris-Smith Kerrison

AN-8-137-01

Laminectomy Punch
1 mm, 2 mm, 3 mm, 4 mm, 5 mm, 6 mm,

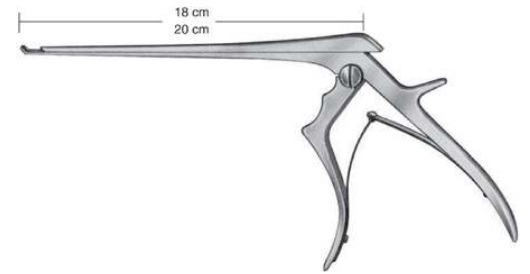

FERRIS-SMITH-KERRISON

AN-9-137-01

with thin footplate

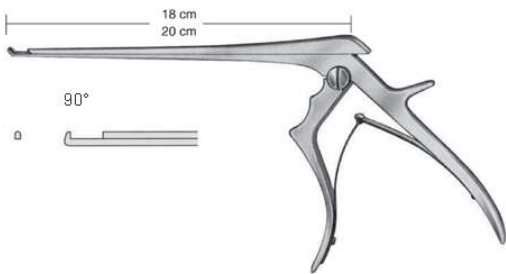

FERRIS-SMITH-KERRISON

AN-9-137-02

With thin footplate

18 cm , 20 cm , 1mm ,2 mm ,3 mm ,4 mm ,5 mm,

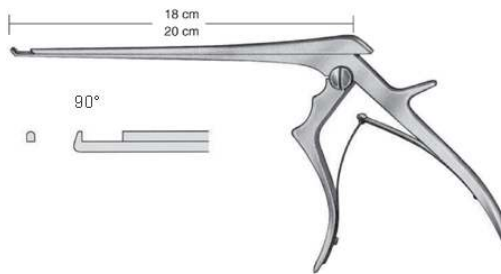

FERRIS-SMITH-KERRISON

AN-9-137-03

With thin footplate

18 cm , 20 cm , 1mm ,2 mm ,3 mm ,4 mm ,5 mm,

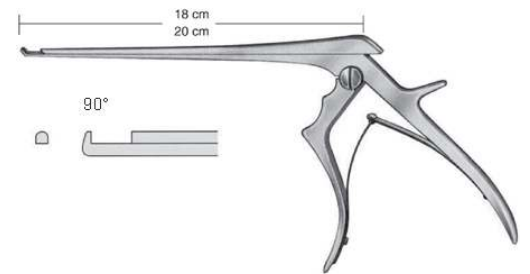

FERRIS-SMITH-KERRISON

AN-9-137-04

With thin footplate

18 cm , 20 cm , 1mm ,2 mm ,3 mm ,4 mm ,5 mm,



Neurosurgery

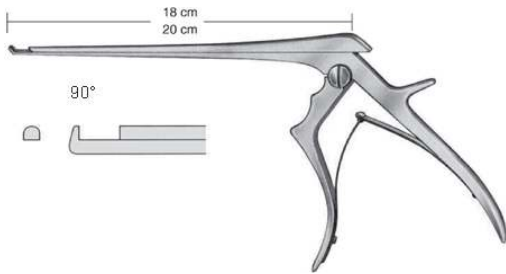

FERRIS-SMITH-KERRISON

AN-9-137-05

With thin footplate

18 cm , 20 cm , 1 mm ,2 mm,3 mm ,4 mm ,5 mm,

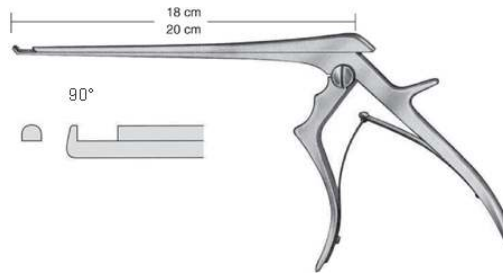

FERRIS-SMITH-KERRISON

AN-9-137-06

With thin footplate

18 cm , 20 cm , 1 mm ,2 mm,3 mm ,4 mm ,5 mm,

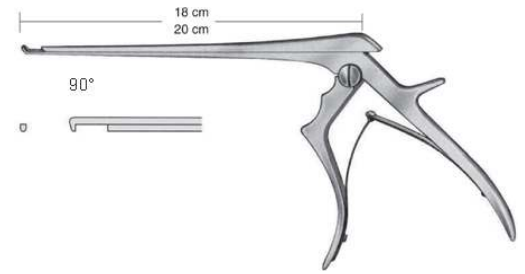

FERRIS-SMITH-KERRISON

AN-9-137-07

with thin footplate

18 cm , 20 cm , 1 mm,2 mm,3 mm,4 mm,5 mm,

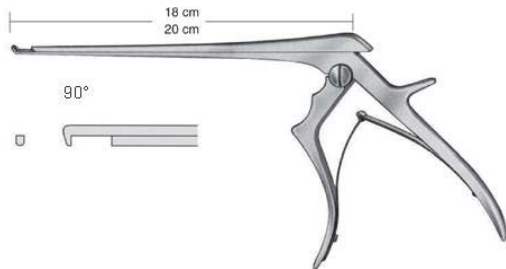

FERRIS-SMITH-KERRISON

AN-9-137-08

with thin footplate

18 cm , 20 cm , 1 mm,2 mm,3 mm,4 mm,5 mm,

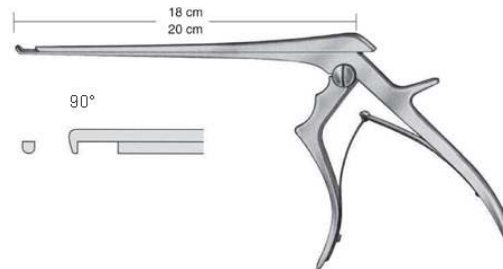

FERRIS-SMITH-KERRISON

AN-9-137-09

with thin footplate

18 cm , 20 cm , 1 mm,2 mm,3 mm,4 mm,5 mm,

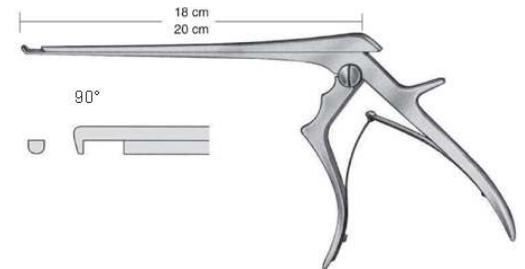

FERRIS-SMITH-KERRISON

AN-9-137-10

with thin footplate

18 cm , 20 cm , 1 mm,2 mm,3 mm,4 mm,5 mm,



Neurosurgery

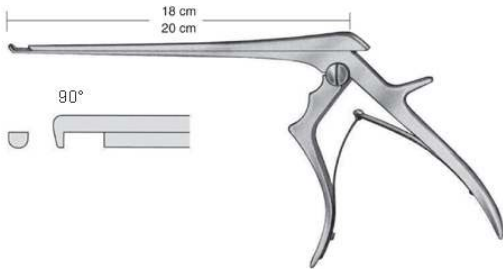

FERRIS-SMITH-KERRISON

AN-9-137-11

with thin footplate

18 cm , 20 cm , 1 mm,2 mm,3 mm,4 mm,5 mm,

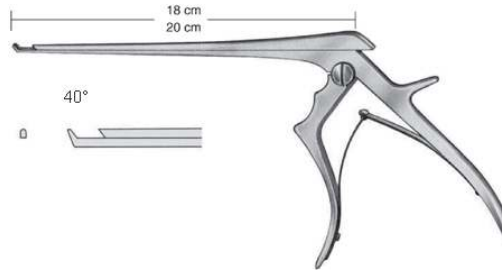

FERRIS-SMITH-KERRISON

AN-9-137-12

with thin footplate

1 mm,2 mm,3 mm,4 mm,5 mm,

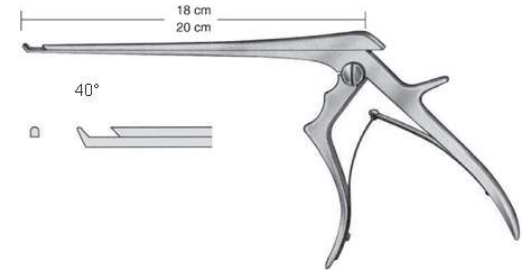

FERRIS-SMITH-KERRISON

AN-9-137-13

with thin footplate

1 mm,2 mm,3 mm,4 mm,5 mm,

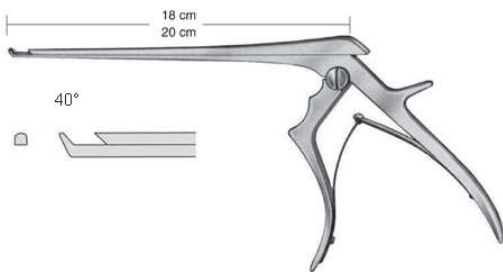

FERRIS-SMITH-KERRISON

AN-9-137-14

with thin footplate

1 mm,2 mm,3 mm,4 mm,5 mm,

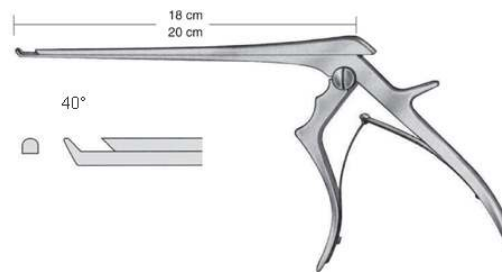

FERRIS-SMITH-KERRISON

AN-9-137-15

with thin footplate

1 mm,2 mm,3 mm,4 mm,5 mm,

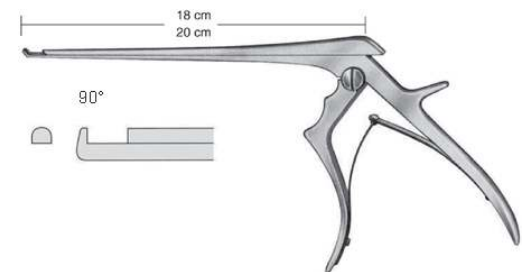

FERRIS-SMITH-KERRISON

AN-9-137-16

with thin footplate

1 mm,2 mm,3 mm,4 mm,5 mm,



Neurosurgery

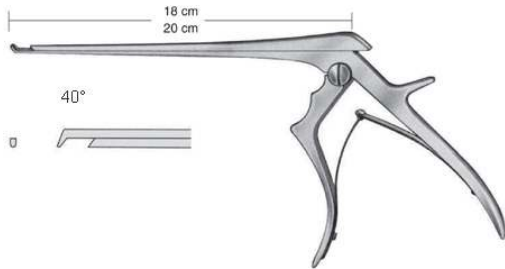

FERRIS-SMITH-KERRISON
AN-9-137-17
with thin footplate
1 mm,2 mm,3 mm,4 mm,5 mm,

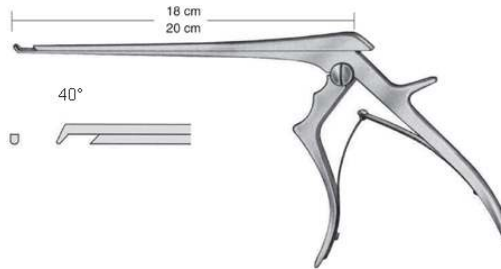

FERRIS-SMITH-KERRISON
AN-9-137-18
with thin footplate
1 mm,2 mm,3 mm,4 mm,5 mm,

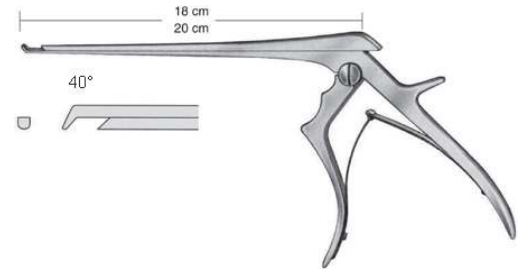

FERRIS-SMITH-KERRISON
AN-9-137-19
with thin footplate
1 mm,2 mm,3 mm,4 mm,5 mm,

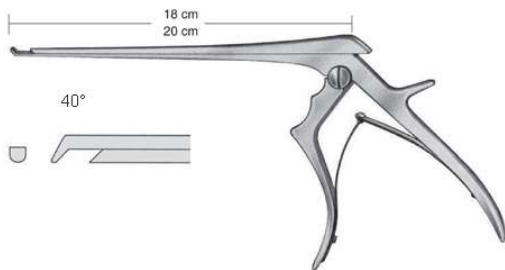

FERRIS-SMITH-KERRISON
AN-9-137-20
with thin footplate
1 mm,2 mm,3 mm,4 mm,5 mm,

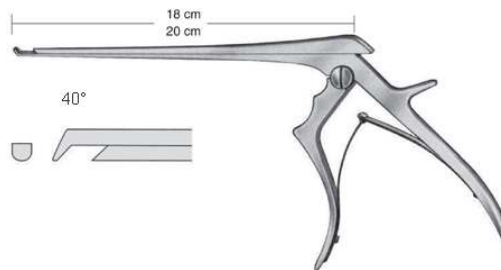

FERRIS-SMITH-KERRISON
AN-9-137-21
with thin footplate
1 mm,2 mm,3 mm,4 mm,5 mm,

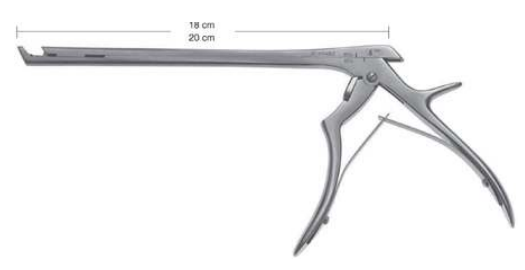

AN-9-137-22
18 cm,20 cm ,



ANARIF CO OÜ
Trader & Supplier

SURGICAL INSTRUMENTS

Neurosurgery

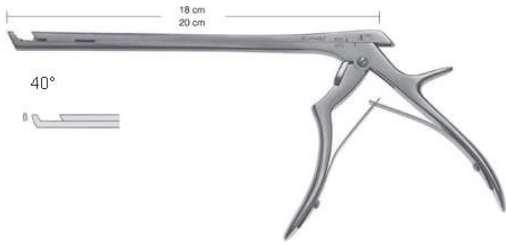

AN-9-137-23

18 cm , 20 cm , 1mm,2 mm,3 mm,4 mm,5 mm,6 mm,

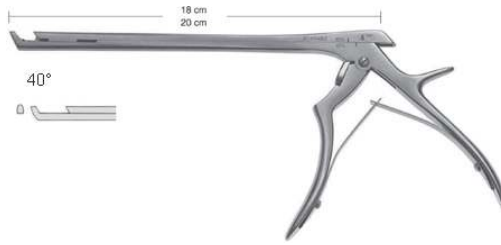

AN-9-137-24

18 cm , 20 cm , 1mm,2 mm,3 mm,4 mm,5 mm,6 mm,



AN-9-137-25

18 cm , 20 cm , 1mm,2 mm,3 mm,4 mm,5 mm,6 mm,

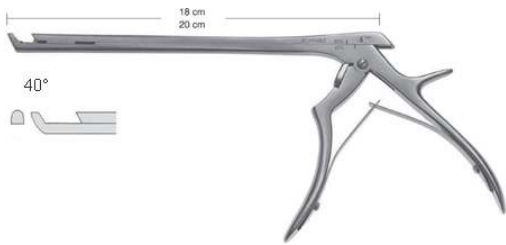

AN-9-137-26

18 cm , 20 cm , 1mm,2 mm,3 mm,4 mm,5 mm,6 mm,

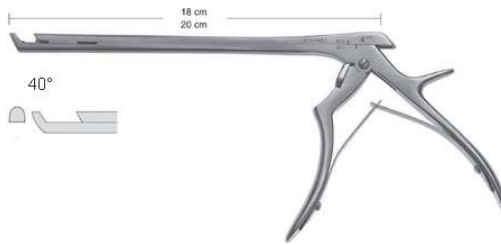

AN-9-137-27

18 cm , 20 cm , 1mm,2 mm,3 mm,4 mm,5 mm,6 mm,

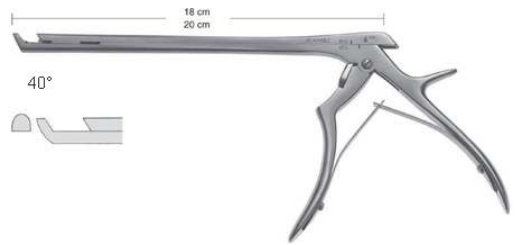

AN-9-137-28

18 cm , 20 cm , 1mm,2 mm,3 mm,4 mm,5 mm,6 mm,



Neurosurgery

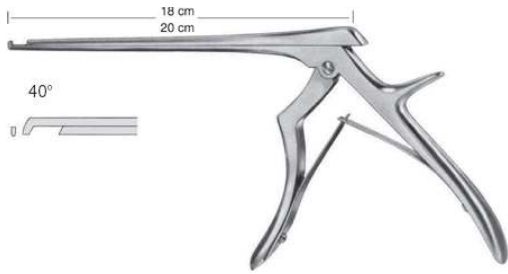

AN-9-137-29

18 cm , 20 cm , 1mm,2 mm,3 mm,4 mm,5 mm,6 mm,

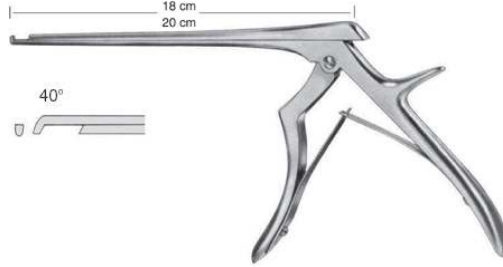

AN-9-137-30

18 cm , 20 cm , 1mm,2 mm,3 mm,4 mm,5 mm,6 mm,

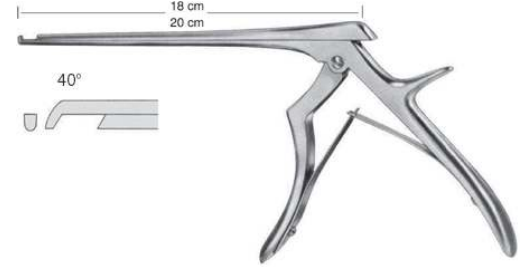

AN-9-137-31

18 cm , 20 cm , 1mm,2 mm,3 mm,4 mm,5 mm,6 mm,

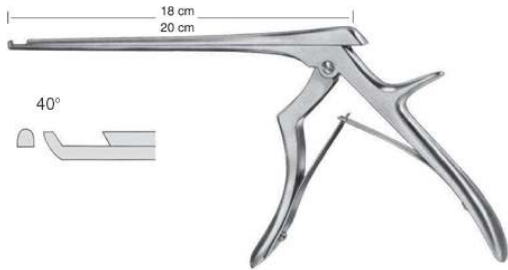

AN-9-137-32

18 cm , 20 cm , 1mm,2 mm,3 mm,4 mm,5 mm,6 mm,

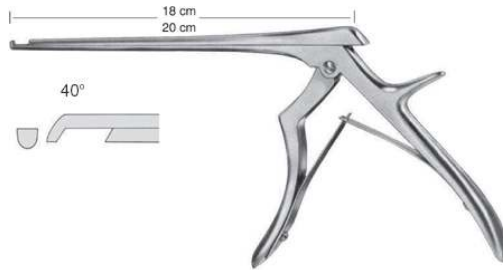

AN-9-137-33

18 cm , 20 cm , 1mm,2 mm,3 mm,4 mm,5 mm,6 mm,

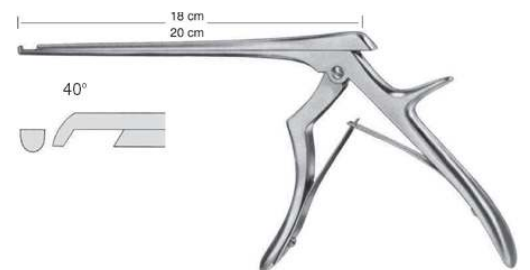

AN-9-137-34

18 cm , 20 cm , 1mm,2 mm,3 mm,4 mm,5 mm,6 mm,



Neurosurgery



detachable
AN-9-137-35
detachable

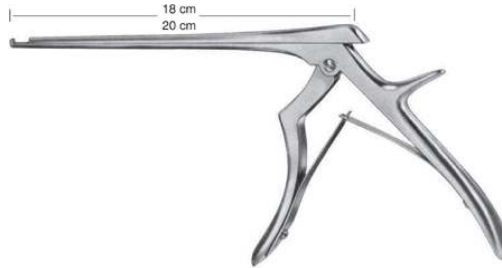

FERRIS-SMITH-KERRISON
AN-9-137-36
FERRIS-SMITH-KERRISON



FERRIS-SMITH-KERRISON
AN-9-137-37
FERRIS-SMITH-KERRISON
18 cm , 20 cm ,
1mm,2mm,3mm,4mm,5mm,6mm,

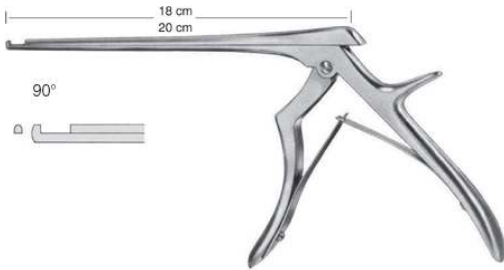

FERRIS-SMITH-KERRISON
AN-9-137-38
FERRIS-SMITH-KERRISON
18 cm , 20 cm , 1mm,18 cm , 20 cm ,
2mm,18 cm , 20 cm , 3mm,18 cm , 20 cm ,
4mm,18 cm , 20 cm , 5mm,18 cm , 20 cm ,
6mm,

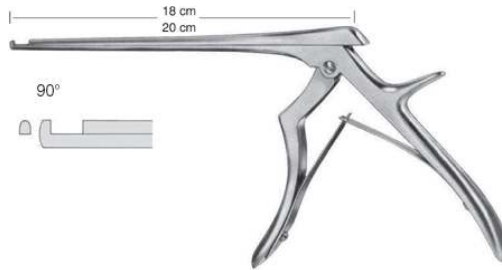

FERRIS-SMITH-KERRISON
AN-9-137-39
FERRIS-SMITH-KERRISON
18 cm , 20 cm , 1mm,18 cm , 20 cm ,
2mm,18 cm , 20 cm , 3mm,18 cm , 20 cm ,
4mm,18 cm , 20 cm , 5mm,18 cm , 20 cm ,
6mm,

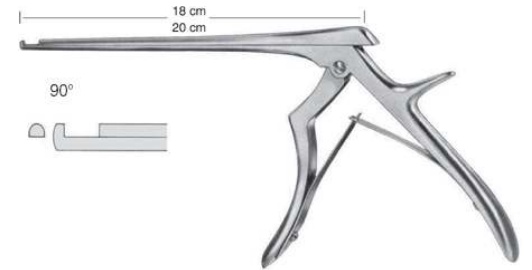

FERRIS-SMITH-KERRISON
AN-9-137-40
FERRIS-SMITH-KERRISON
18 cm , 20 cm , 1mm,18 cm , 20 cm ,
2mm,18 cm , 20 cm , 3mm,18 cm , 20 cm ,
4mm,18 cm , 20 cm , 5mm,18 cm , 20 cm ,
6mm,



Neurosurgery

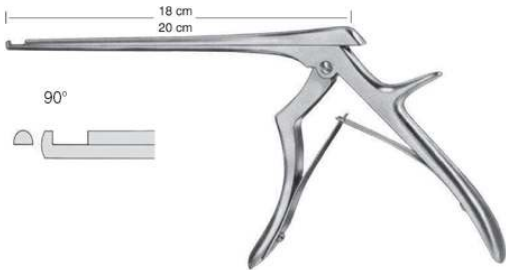

FERRIS-SMITH-KERRISON

AN-9-137-41

FERRIS-SMITH-KERRISON

18 cm , 20 cm , 1mm,18 cm , 20 cm ,
2mm,18 cm , 20 cm , 3mm,18 cm , 20 cm ,
4mm,18 cm , 20 cm , 5mm,18 cm , 20 cm ,
6mm,

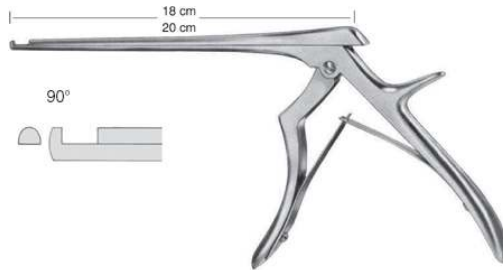

FERRIS-SMITH-KERRISON

AN-9-137-42

FERRIS-SMITH-KERRISON

18 cm , 20 cm , 1mm,18 cm , 20 cm ,
2mm,18 cm , 20 cm , 3mm,18 cm , 20 cm ,
4mm,18 cm , 20 cm , 5mm,18 cm , 20 cm ,
6mm,

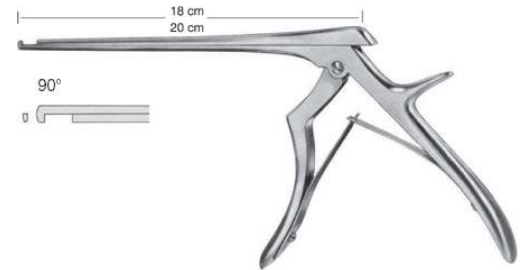

FERRIS-SMITH-KERRISON

AN-9-137-43

FERRIS-SMITH-KERRISON

18 cm , 20 cm , 1mm,18 cm , 20 cm ,
2mm,18 cm , 20 cm , 3mm,18 cm , 20 cm ,
4mm,18 cm , 20 cm , 5mm,18 cm , 20 cm ,
6mm,

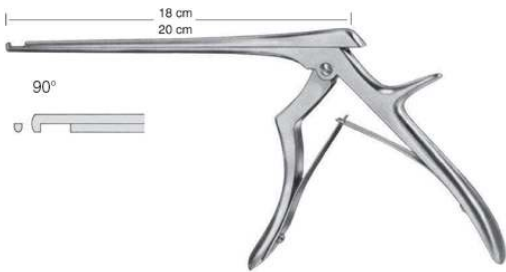

FERRIS-SMITH-KERRISON

AN-9-137-44

FERRIS-SMITH-KERRISON

18 cm , 20 cm , 1mm,18 cm , 20 cm ,
2mm,18 cm , 20 cm , 3mm,18 cm , 20 cm ,
4mm,18 cm , 20 cm , 5mm,18 cm , 20 cm ,
6mm,

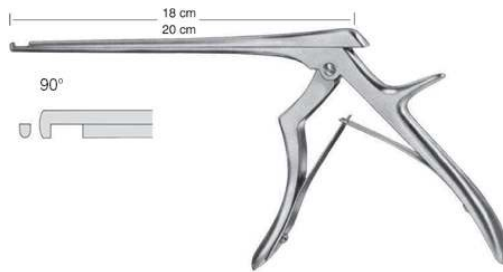

FERRIS-SMITH-KERRISON

AN-9-137-45

FERRIS-SMITH-KERRISON

18 cm , 20 cm , 1mm,18 cm , 20 cm ,
2mm,18 cm , 20 cm , 3mm,18 cm , 20 cm ,
4mm,18 cm , 20 cm , 5mm,18 cm , 20 cm ,
6mm,

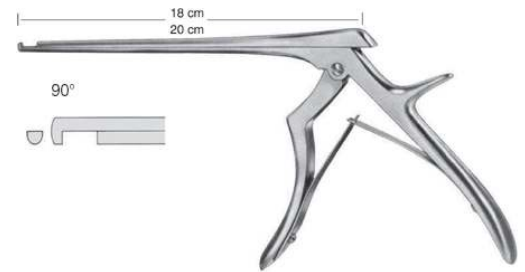

FERRIS-SMITH-KERRISON

AN-9-137-46

FERRIS-SMITH-KERRISON

18 cm , 20 cm , 1mm,18 cm , 20 cm ,
2mm,18 cm , 20 cm , 3mm,18 cm , 20 cm ,
4mm,18 cm , 20 cm , 5mm,18 cm , 20 cm ,
6mm,



Neurosurgery

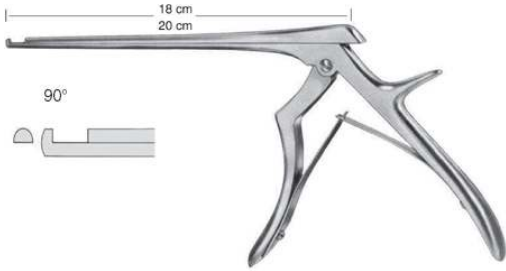

FERRIS-SMITH-KERRISON

AN-9-137-41

FERRIS-SMITH-KERRISON

18 cm , 20 cm , 1mm,18 cm , 20 cm ,
2mm,18 cm , 20 cm , 3mm,18 cm , 20 cm ,
4mm,18 cm , 20 cm , 5mm,18 cm , 20 cm ,
6mm,

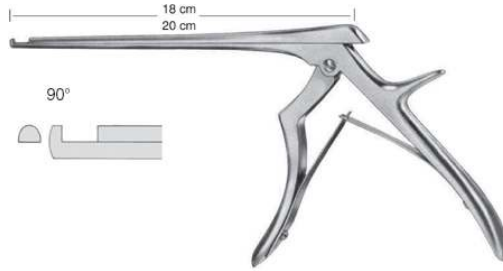

FERRIS-SMITH-KERRISON

AN-9-137-42

FERRIS-SMITH-KERRISON

18 cm , 20 cm , 1mm,18 cm , 20 cm ,
2mm,18 cm , 20 cm , 3mm,18 cm , 20 cm ,
4mm,18 cm , 20 cm , 5mm,18 cm , 20 cm ,
6mm,

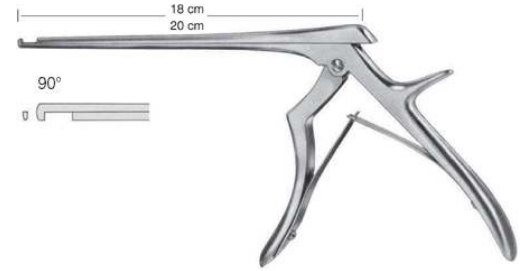

FERRIS-SMITH-KERRISON

AN-9-137-43

FERRIS-SMITH-KERRISON

18 cm , 20 cm , 1mm,18 cm , 20 cm ,
2mm,18 cm , 20 cm , 3mm,18 cm , 20 cm ,
4mm,18 cm , 20 cm , 5mm,18 cm , 20 cm ,
6mm,

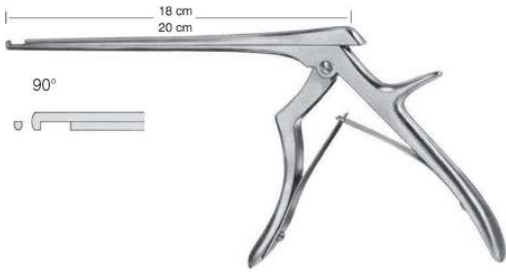

FERRIS-SMITH-KERRISON

AN-9-137-44

FERRIS-SMITH-KERRISON

18 cm , 20 cm , 1mm,18 cm , 20 cm ,
2mm,18 cm , 20 cm , 3mm,18 cm , 20 cm ,
4mm,18 cm , 20 cm , 5mm,18 cm , 20 cm ,
6mm,

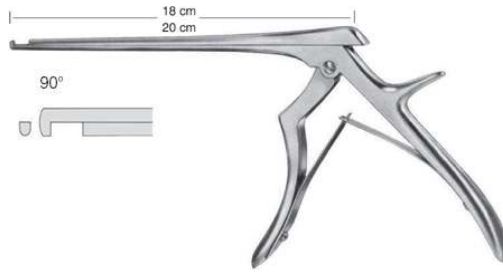

FERRIS-SMITH-KERRISON

AN-9-137-45

FERRIS-SMITH-KERRISON

18 cm , 20 cm , 1mm,18 cm , 20 cm ,
2mm,18 cm , 20 cm , 3mm,18 cm , 20 cm ,
4mm,18 cm , 20 cm , 5mm,18 cm , 20 cm ,
6mm,

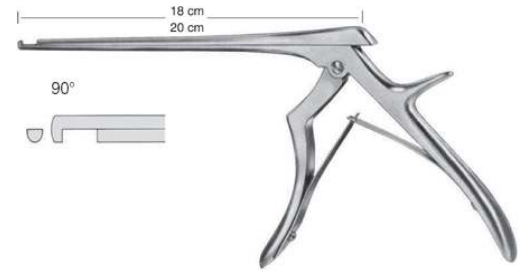

FERRIS-SMITH-KERRISON

AN-9-137-46

FERRIS-SMITH-KERRISON

18 cm , 20 cm , 1mm,18 cm , 20 cm ,
2mm,18 cm , 20 cm , 3mm,18 cm , 20 cm ,
4mm,18 cm , 20 cm , 5mm,18 cm , 20 cm ,
6mm,



Neurosurgery

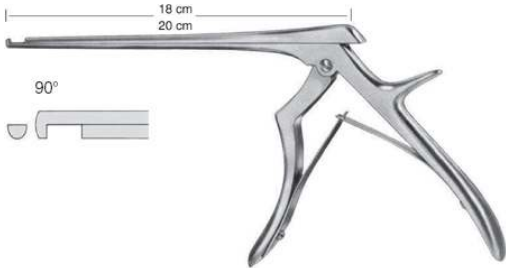

FERRIS-SMITH-KERRISON

AN-9-137-47

FERRIS-SMITH-KERRISON

18 cm , 20 cm , 1mm,18 cm , 20 cm ,
2mm,18 cm , 20 cm , 3mm,18 cm , 20 cm ,
4mm,18 cm , 20 cm , 5mm,18 cm , 20 cm ,
6mm,

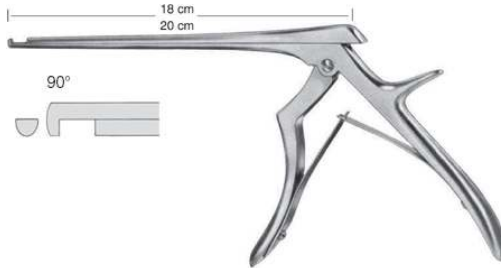

FERRIS-SMITH-KERRISON

AN-9-137-48

FERRIS-SMITH-KERRISON

18 cm , 20 cm , 1mm,18 cm , 20 cm ,
2mm,18 cm , 20 cm , 3mm,18 cm , 20 cm ,
4mm,18 cm , 20 cm , 5mm,18 cm , 20 cm ,
6mm,

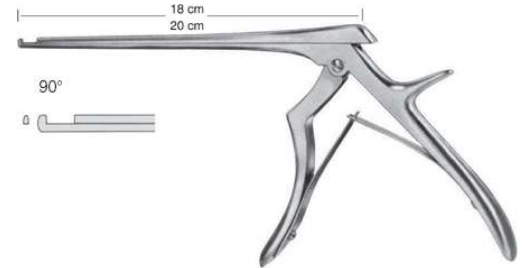

FERRIS-SMITH-KERRISON

AN-9-137-49

FERRIS-SMITH-KERRISON

18 cm , 20 cm , 1mm,18 cm , 20 cm ,
2mm,18 cm , 20 cm , 3mm,18 cm , 20 cm ,
4mm,18 cm , 20 cm , 5mm,18 cm , 20 cm ,
6mm,

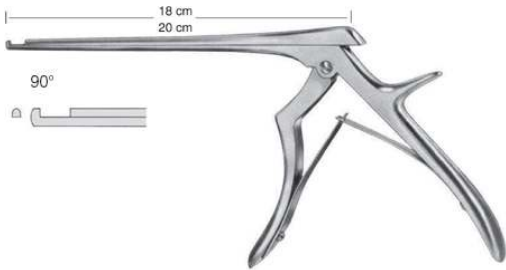

FERRIS-SMITH-KERRISON

AN-9-137-50

FERRIS-SMITH-KERRISON

18 cm , 20 cm , 1mm,18 cm , 20 cm ,
2mm,18 cm , 20 cm , 3mm,18 cm , 20 cm ,
4mm,18 cm , 20 cm , 5mm,18 cm , 20 cm ,
6mm,

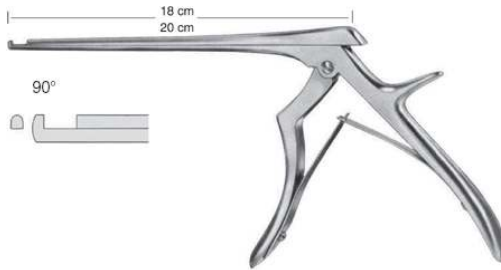

FERRIS-SMITH-KERRISON

AN-9-137-51

FERRIS-SMITH-KERRISON

18 cm , 20 cm , 1mm,18 cm , 20 cm ,
2mm,18 cm , 20 cm , 3mm,18 cm , 20 cm ,
4mm,18 cm , 20 cm , 5mm,18 cm , 20 cm ,
6mm,

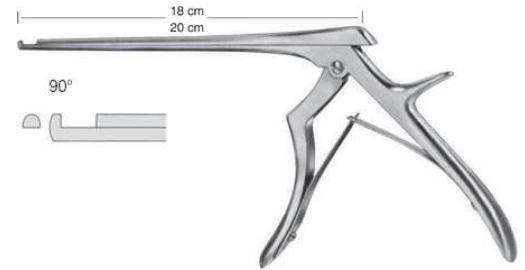

FERRIS-SMITH-KERRISON

AN-9-137-52

FERRIS-SMITH-KERRISON

18 cm , 20 cm , 1mm,18 cm , 20 cm ,
2mm,18 cm , 20 cm , 3mm,18 cm , 20 cm ,
4mm,18 cm , 20 cm , 5mm,18 cm , 20 cm ,
6mm,



Neurosurgery

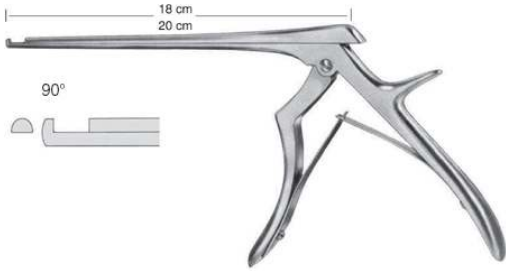

FERRIS-SMITH-KERRISON

AN-9-137-53

FERRIS-SMITH-KERRISON

18 cm , 20 cm , 1mm,18 cm , 20 cm ,
2mm,18 cm , 20 cm , 3mm,18 cm , 20 cm ,
4mm,18 cm , 20 cm , 5mm,18 cm , 20 cm ,
6mm,

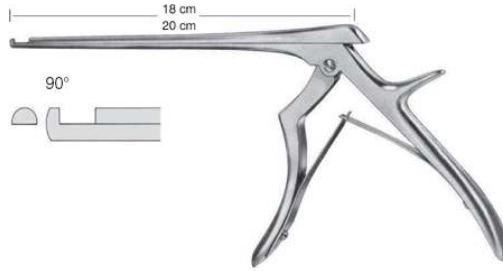

FERRIS-SMITH-KERRISON

AN-9-137-54

FERRIS-SMITH-KERRISON

18 cm , 20 cm , 1mm,18 cm , 20 cm ,
2mm,18 cm , 20 cm , 3mm,18 cm , 20 cm ,
4mm,18 cm , 20 cm , 5mm,18 cm , 20 cm ,
6mm,

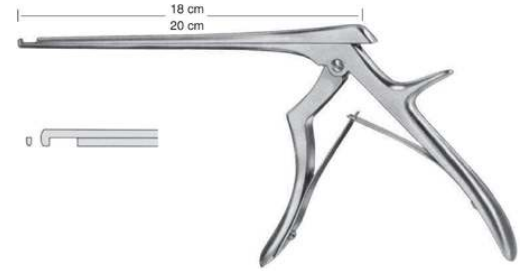

FERRIS-SMITH-KERRISON

AN-9-137-55

FERRIS-SMITH-KERRISON

18 cm , 20 cm , 1mm,18 cm , 20 cm ,
2mm,18 cm , 20 cm , 3mm,18 cm , 20 cm ,
4mm,18 cm , 20 cm , 5mm,18 cm , 20 cm ,
6mm,



FERRIS-SMITH-KERRISON

AN-9-137-56

FERRIS-SMITH-KERRISON

18 cm , 20 cm , 1mm,18 cm , 20 cm ,
2mm,18 cm , 20 cm , 3mm,18 cm , 20 cm ,
4mm,18 cm , 20 cm , 5mm,18 cm , 20 cm ,
6mm,

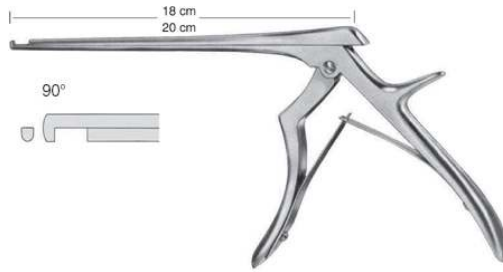

FERRIS-SMITH-KERRISON

AN-9-137-57

FERRIS-SMITH-KERRISON

18 cm , 20 cm , 1mm,18 cm , 20 cm ,
2mm,18 cm , 20 cm , 3mm,18 cm , 20 cm ,
4mm,18 cm , 20 cm , 5mm,18 cm , 20 cm ,
6mm,

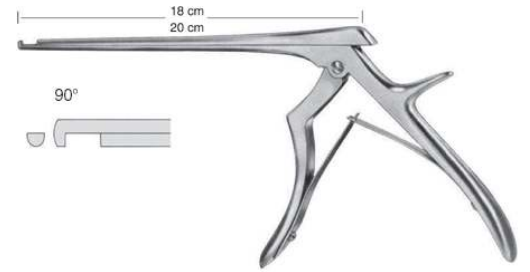

FERRIS-SMITH-KERRISON

AN-9-137-58

FERRIS-SMITH-KERRISON

18 cm , 20 cm , 1mm,18 cm , 20 cm ,
2mm,18 cm , 20 cm , 3mm,18 cm , 20 cm ,
4mm,18 cm , 20 cm , 5mm,18 cm , 20 cm ,
6mm,



Neurosurgery

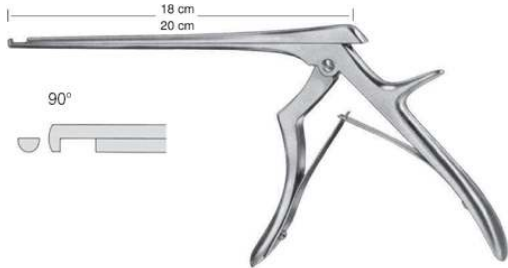

FERRIS-SMITH-KERRISON

AN-9-137-59

FERRIS-SMITH-KERRISON

18 cm , 20 cm , 1mm,18 cm , 20 cm ,
2mm,18 cm , 20 cm , 3mm,18 cm , 20 cm ,
4mm,18 cm , 20 cm , 5mm,18 cm , 20 cm ,
6mm,

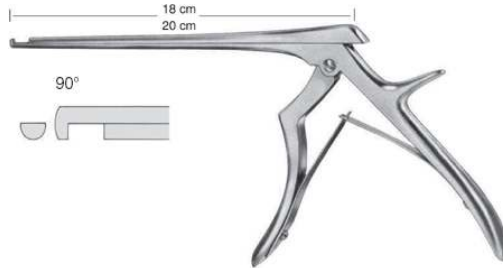

FERRIS-SMITH-KERRISON

AN-9-137-60

FERRIS-SMITH-KERRISON

18 cm , 20 cm , 1mm,18 cm , 20 cm ,
2mm,18 cm , 20 cm , 3mm,18 cm , 20 cm ,
4mm,18 cm , 20 cm , 5mm,18 cm , 20 cm ,
6mm,

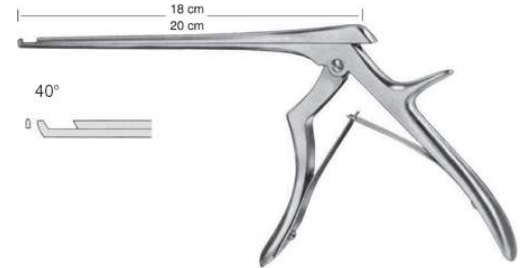

FERRIS-SMITH-KERRISON

AN-9-137-61

FERRIS-SMITH-KERRISON

18 cm , 20 cm , 1mm,18 cm , 20 cm ,
2mm,18 cm , 20 cm , 3mm,18 cm , 20 cm ,
4mm,18 cm , 20 cm , 5mm,18 cm , 20 cm ,
6mm,

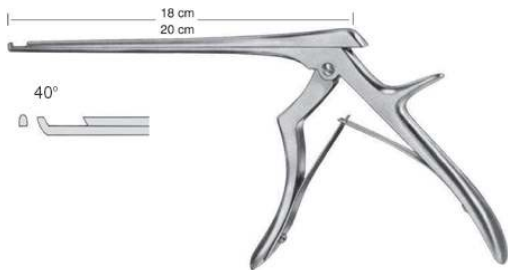

FERRIS-SMITH-KERRISON

AN-9-137-62

FERRIS-SMITH-KERRISON

18 cm , 20 cm , 1mm,18 cm , 20 cm ,
2mm,18 cm , 20 cm , 3mm,18 cm , 20 cm ,
4mm,18 cm , 20 cm , 5mm,18 cm , 20 cm ,
6mm,

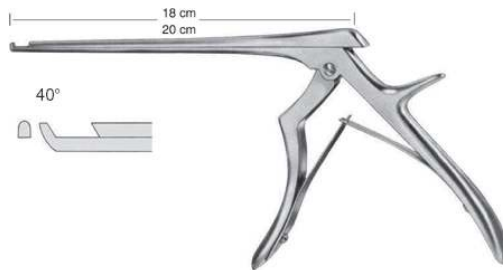

FERRIS-SMITH-KERRISON

AN-9-137-63

FERRIS-SMITH-KERRISON

18 cm , 20 cm , 1mm,18 cm , 20 cm ,
2mm,18 cm , 20 cm , 3mm,18 cm , 20 cm ,
4mm,18 cm , 20 cm , 5mm,18 cm , 20 cm ,
6mm,

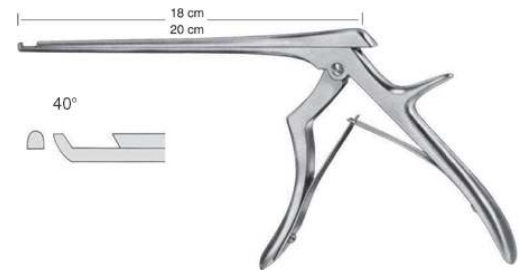

FERRIS-SMITH-KERRISON

AN-9-137-64

FERRIS-SMITH-KERRISON

18 cm , 20 cm , 1mm,18 cm , 20 cm ,
2mm,18 cm , 20 cm , 3mm,18 cm , 20 cm ,
4mm,18 cm , 20 cm , 5mm,18 cm , 20 cm ,
6mm,



Neurosurgery

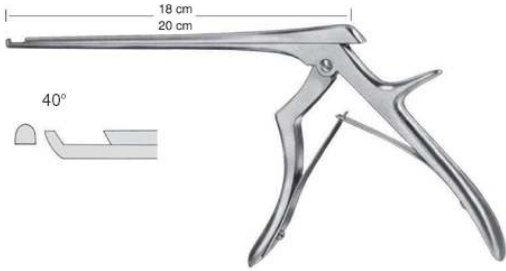

FERRIS-SMITH-KERRISON

AN-9-137-65

FERRIS-SMITH-KERRISON

18 cm , 20 cm , 1mm,18 cm , 20 cm ,
2mm,18 cm , 20 cm , 3mm,18 cm , 20 cm ,
4mm,18 cm , 20 cm , 5mm,18 cm , 20 cm ,
6mm,

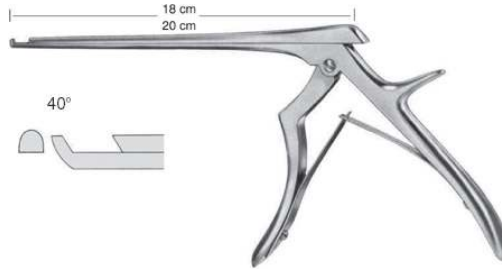

FERRIS-SMITH-KERRISON

AN-9-137-66

FERRIS-SMITH-KERRISON

18 cm , 20 cm , 1mm,18 cm , 20 cm ,
2mm,18 cm , 20 cm , 3mm,18 cm , 20 cm ,
4mm,18 cm , 20 cm , 5mm,18 cm , 20 cm ,
6mm,

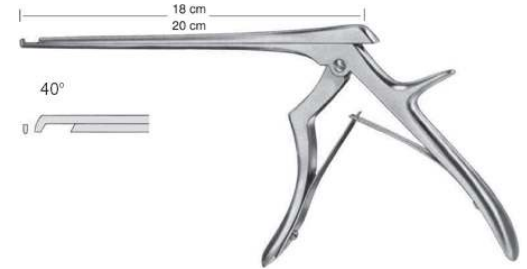

FERRIS-SMITH-KERRISON

AN-9-137-67

FERRIS-SMITH-KERRISON

18 cm , 20 cm , 1mm,18 cm , 20 cm ,
2mm,18 cm , 20 cm , 3mm,18 cm , 20 cm ,
4mm,18 cm , 20 cm , 5mm,18 cm , 20 cm ,
6mm,



FERRIS-SMITH-KERRISON

AN-9-137-68

FERRIS-SMITH-KERRISON

18 cm , 20 cm , 1mm,18 cm , 20 cm ,
2mm,18 cm , 20 cm , 3mm,18 cm , 20 cm ,
4mm,18 cm , 20 cm , 5mm,18 cm , 20 cm ,
6mm,

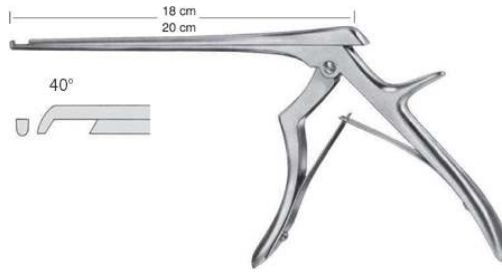

FERRIS-SMITH-KERRISON

AN-9-137-69

FERRIS-SMITH-KERRISON

18 cm , 20 cm , 1mm,18 cm , 20 cm ,
2mm,18 cm , 20 cm , 3mm,18 cm , 20 cm ,
4mm,18 cm , 20 cm , 5mm,18 cm , 20 cm ,
6mm,

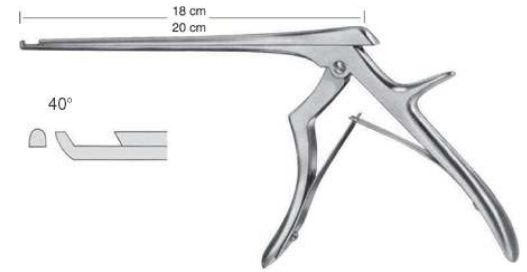

FERRIS-SMITH-KERRISON

AN-9-137-70

FERRIS-SMITH-KERRISON

18 cm , 20 cm , 1mm,18 cm , 20 cm ,
2mm,18 cm , 20 cm , 3mm,18 cm , 20 cm ,
4mm,18 cm , 20 cm , 5mm,18 cm , 20 cm ,
6mm,



Neurosurgery

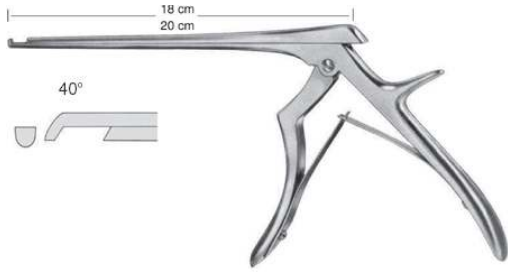

FERRIS-SMITH-KERRISON
AN-9-137-71

FERRIS-SMITH-KERRISON
18 cm , 20 cm , 1mm,18 cm , 20 cm ,
2mm,18 cm , 20 cm , 3mm,18 cm , 20 cm ,
4mm,18 cm , 20 cm , 5mm,18 cm , 20 cm ,
6mm,

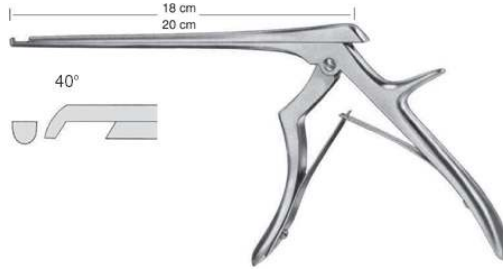

FERRIS-SMITH-KERRISON
AN-9-137-72

FERRIS-SMITH-KERRISON
18 cm , 20 cm , 1mm,18 cm , 20 cm ,
2mm,18 cm , 20 cm , 3mm,18 cm , 20 cm ,
4mm,18 cm , 20 cm , 5mm,18 cm , 20 cm ,
6mm,

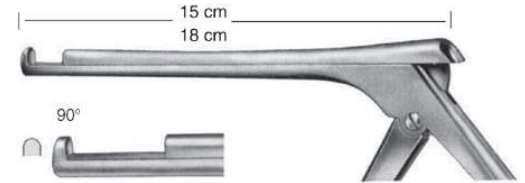

COLCLOUGH
AN-9-137-73

COLCLOUGH
3 mm
5 mm

15 cm,18 cm,

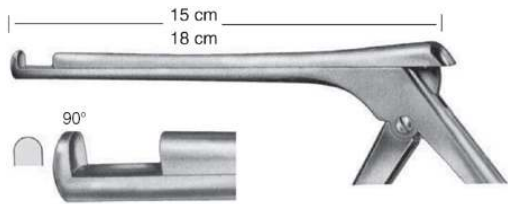

COLCLOUGH
AN-9-137-74
COLCLOUGH
3 mm
5 mm
15 cm,18 cm,

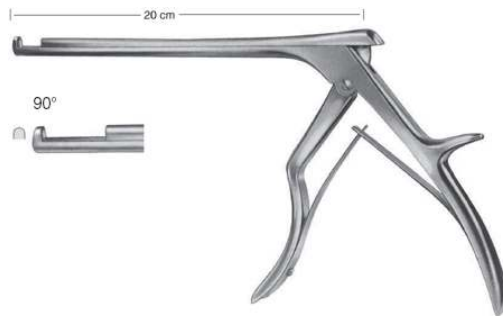

COLCLOUGH
AN-9-137-75
COLCLOUGH
3 mm
5 mm
20 cm,

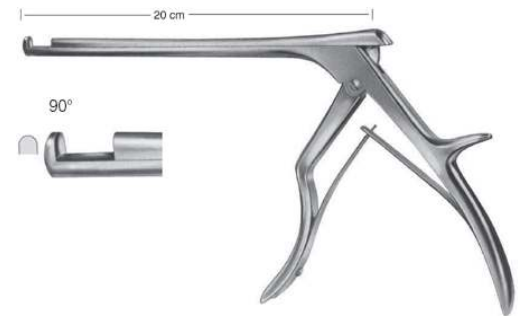

COLCLOUGH
AN-9-137-76
COLCLOUGH
3 mm
5 mm
20 cm,



ANARIF CO OÜ
 Trader & Supplier

SURGICAL INSTRUMENTS

Neurosurgery

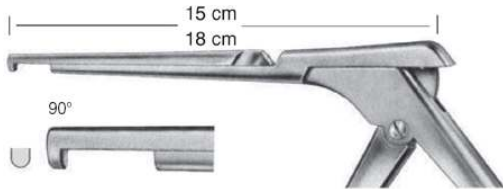

COLCLOUGH
 AN-9-137-77
 COLCLOUGH
 3 mm
 5 mm
 15 cm, 18 cm,

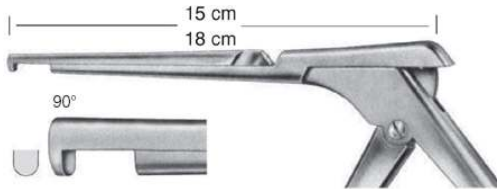

COLCLOUGH
 AN-9-137-78
 COLCLOUGH
 3 mm
 5 mm
 15 cm, 18 cm,

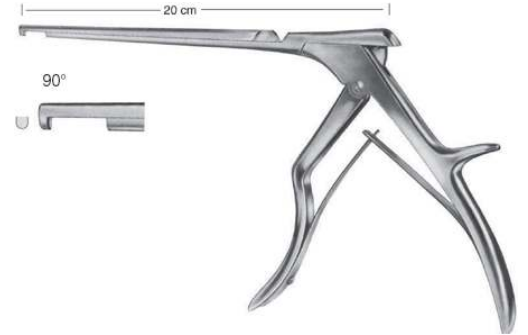

COLCLOUGH
 AN-9-137-79
 COLCLOUGH
 3 mm
 5 mm
 20 cm,

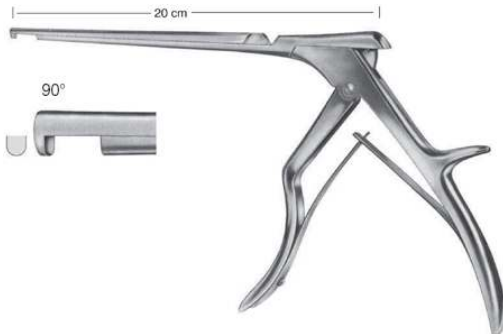

COLCLOUGH
 AN-9-137-80
 COLCLOUGH
 3 mm
 5 mm
 20 cm,



COLCLOUGH
 AN-9-137-81
 COLCLOUGH
 3 mm
 5 mm
 15 cm, 18 cm,

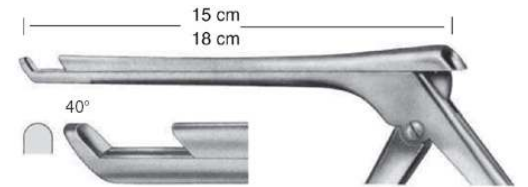

COLCLOUGH
 AN-9-137-82
 COLCLOUGH
 3 mm
 5 mm
 15 cm, 18 cm,



Neurosurgery

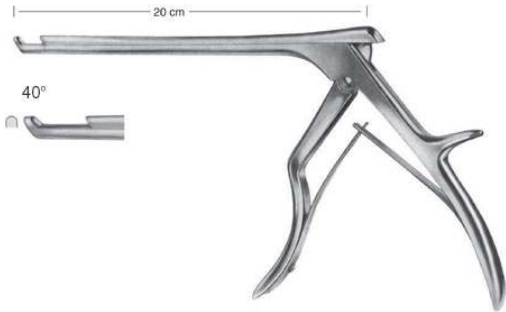

COLCLOUGH
AN-9-137-83
COLCLOUGH
3 mm
5 mm
20 cm,

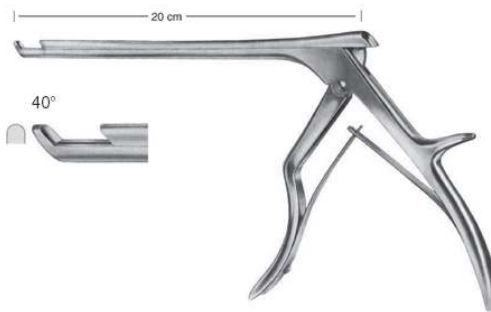

COLCLOUGH
AN-9-137-84
COLCLOUGH
3 mm
5 mm
20 cm,

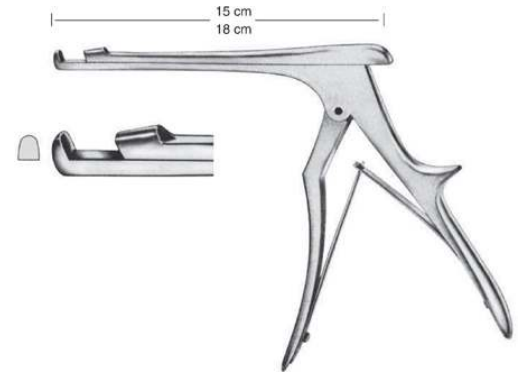

RANEY
AN-9-137-85
RANEY
15 cm / 6mm, 18 cm / 6mm,

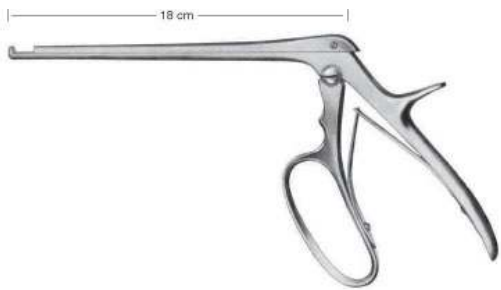

FERRIS-SMITH-KERRISON
AN-9-137-86
FERRIS-SMITH-KERRISON
18 cm,

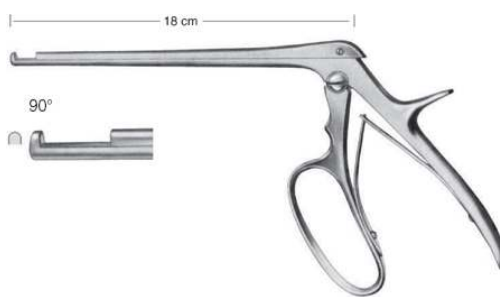

FERRIS-SMITH-KERRISON
AN-9-137-87
FERRIS-SMITH-KERRISON
3x3 mm,

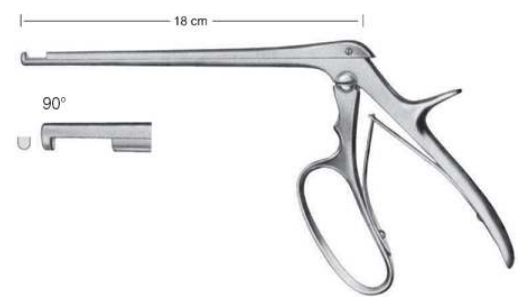

FERRIS-SMITH-KERRISON
AN-9-137-88
FERRIS-SMITH-KERRISON
3x3 mm,



Neurosurgery

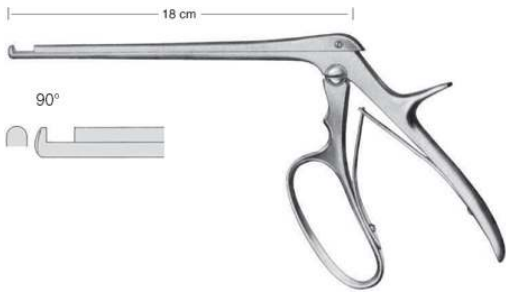

FERRIS-SMITH-KERRISON
AN-9-137-89
FERRIS-SMITH-KERRISON
5x5 mm,

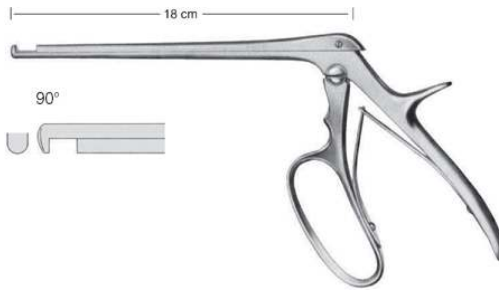

FERRIS-SMITH-KERRISON
AN-9-137-90
FERRIS-SMITH-KERRISON
5x5 mm,

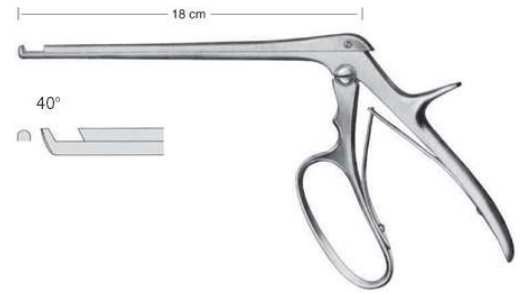

FERRIS-SMITH-KERRISON
AN-9-137-91
FERRIS-SMITH-KERRISON
3 mm,

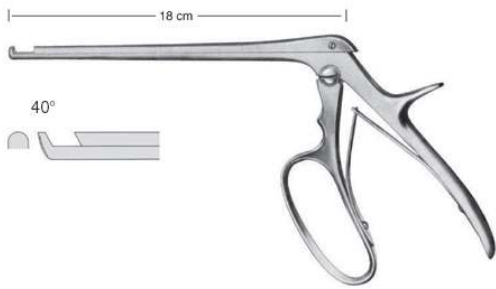

FERRIS-SMITH-KERRISON
AN-9-137-92
FERRIS-SMITH-KERRISON
5 mm,

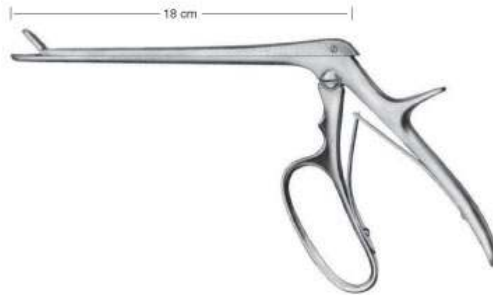

FERRIS-SMITH-CUSHING
AN-9-137-93
FERRIS-SMITH-CUSHING
18 cm,

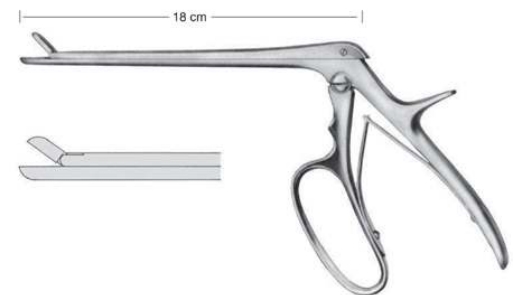

FERRIS-SMITH-CUSHING
AN-9-137-94
FERRIS-SMITH-CUSHING
2 x 10 mm, 3 x 10 mm, 4 x 10 mm, 5 x 10 mm, 6 x 10 mm,



Neurosurgery

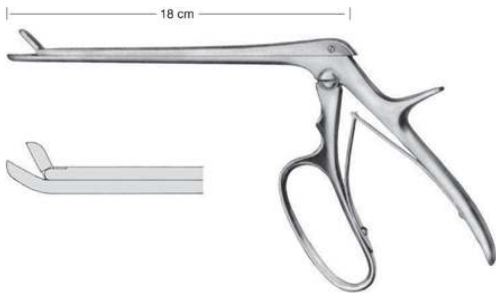

FERRIS-SMITH-CUSHING

AN-9-137-95

FERRIS-SMITH-CUSHING

2 x 10 mm, 3 x 10 mm, 4 x 10 mm, 5 x 10 mm, 6 x 10 mm,

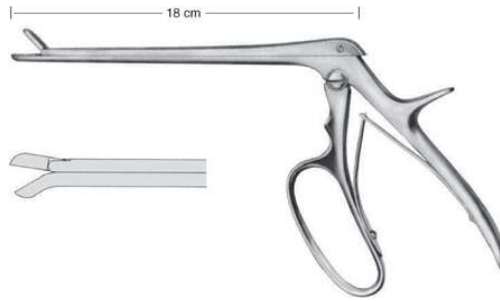

FERRIS-SMITH-CUSHING

AN-9-137-96

FERRIS-SMITH-CUSHING

2 x 10 mm, 3 x 10 mm, 4 x 10 mm, 5 x 10 mm, 6 x 10 mm,

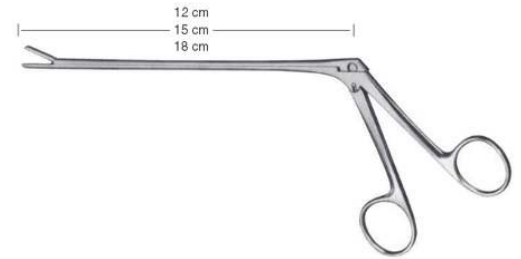

CUSHING

AN-9-137-97

CUSHING

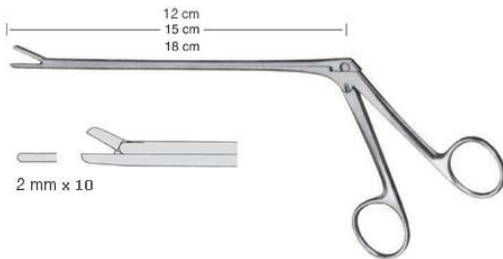

CUSHING

AN-9-137-98

CUSHING

2 mm x 10, 12 cm, 15 cm, 18 cm,

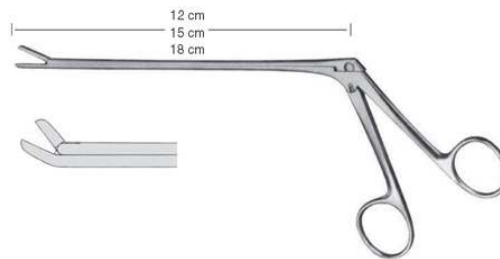

CUSHING

AN-9-137-99

CUSHING

2 mm x 10, 12 cm, 15 cm, 18 cm,

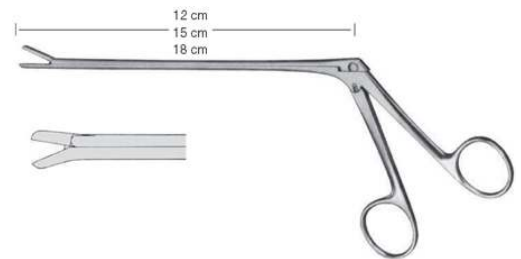

CUSHING

AN-9-137-100

CUSHING

2 mm x 10, 12 cm, 15 cm, 18 cm,



Neurosurgery

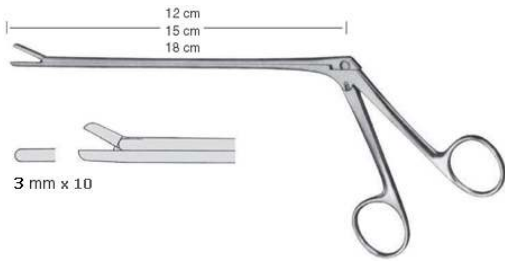

LOVE-GRUENWALD
AN-9-137-101
LOVE-GRUENWALD
3 mm x 10,12 cm,15 cm,18 cm,

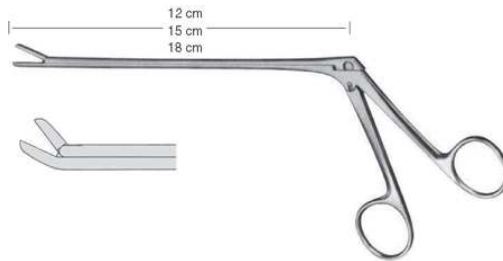

LOVE-GRUENWALD
AN-9-137-102
LOVE-GRUENWALD
3 mm x 10,12 cm,15 cm,18 cm,

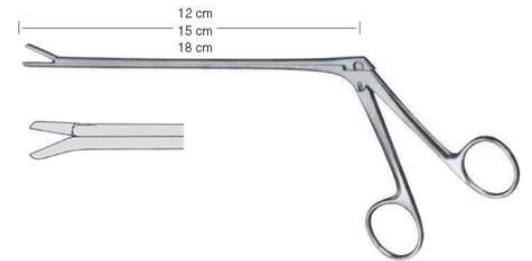

LOVE-GRUENWALD
AN-9-137-103
LOVE-GRUENWALD
3 mm x 10,12 cm,15 cm,18 cm,

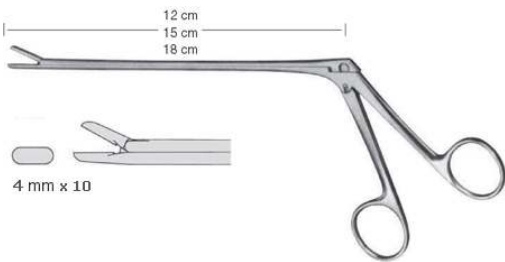

SPURLING
AN-9-137-104
SPURLING
4 mm x 10,12 cm,15 cm,18 cm,

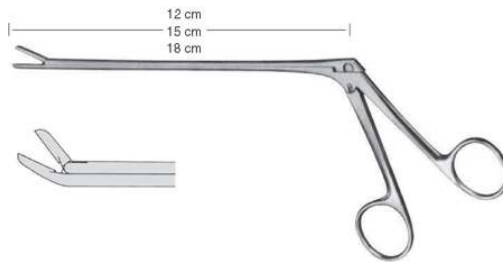

SPURLING
AN-9-137-105
SPURLING
4 mm x 10,12 cm,15 cm,18 cm,



SPURLING
AN-9-137-106
SPURLING
4 mm x 10,12 cm,15 cm,18 cm,



ANARIF CO OU
 Trader & Supplier

SURGICAL INSTRUMENTS

Neurosurgery



7 mm

OLDAMZRG
 AN-9-137-107
 OLDAMZRG
 18 cm,



SCHLESINGER
 AN-9-137-108
 SCHLESINGER
 15 cm, 2 x 10 mm, 3 x 10 mm, 4 x 10 mm, 5 x 10 mm,



CAMZPAR
 AN-9-137-109
 CAMZPAR
 2 mm, 14 cm, 15 cm, 16 cm, 18.5 cm,



CAMZPAR
 AN-9-137-110
 CAMZPAR
 3 mm, 14 cm, 15 cm, 16 cm, 18.5 cm,



CAMZPAR
 AN-9-137-111
 CAMZPAR
 4 mm, 14 cm, 15 cm, 16 cm, 18.5 cm,



CAMZPAR
 AN-9-137-112
 CAMZPAR
 5 mm, 14 cm, 15 cm, 16 cm, 18.5 cm,



ANARIF CO OU
Trader & Supplier

SURGICAL INSTRUMENTS

Neurosurgery



CAMZPAR
AN-9-137-113
CAMZPAR
2 mm, 14 cm, 15 cm, 16 cm, 18.5 cm,



CAMZPAR
AN-9-137-114
CAMZPAR
3 mm, 14 cm, 15 cm, 16 cm, 18.5 cm,



CAMZPAR
AN-9-137-115
CAMZPAR
4 mm, 14 cm, 15 cm, 16 cm, 18.5 cm,



CAMZPAR
AN-9-137-116
CAMZPAR
2 mm, 14 cm, 15 cm, 16 cm, 18.5 cm,



CAMZPAR
AN-9-137-117
CAMZPAR
3 mm, 14 cm, 15 cm, 16 cm, 18.5 cm,



CAMZPAR
AN-9-137-118
CAMZPAR
4 mm, 14 cm, 15 cm, 16 cm, 18.5 cm,



ANARIF CO OÜ
Trader & Supplier

SURGICAL INSTRUMENTS

Neurosurgery



YAMZARGIL
AN-9-137-119
YAMZARGIL
25 cm, 2.2 cm, 3.5 cm, 4.0 cm,



LANDOLT
AN-9-137-120
LANDOLT
27 cm, 9 mm,



OLIVECRONA-TOENNIS
AN-9-137-121
14 cm,



Cardiovascular



AN-9-101-23
Bone Shear
23 cm,



AN-9-102-22
Rib Shear
23 cm,



Gluck
AN-9-103-22
Rib Shears
21 cm,



Giertz-Stille
AN-9-104-27
Rib Shear
24.5 cm,



Lebsche
AN-9-105-24
Sternum Chisel
24.5 cm,



AN-9-106-01
Rib Retractor lateral blades 12 x 16 mm
spreading 95 mm
Size 1,



Cardiovascular



Finochietto, Infant
AN-9-107-01

Rib Retractor lateral blades 15 x 15 mm
spreading 75 mm
Size 1,



Finochietto, Baby
AN-9-108-01

Rib Retractor lateral blades 31 x 31 mm
spreading 100 mm
Size 1,



Finochietto
AN-9-109-01

Rib Retractor lateral blades 40 x 45 mm
spreading 135 mm
Size 1,



Burford
AN-9-110-01

Rib Retractor with two pairs of blades 47 x 62 mm + 65 x 62 mm, spreading 200 mm
Size 1,



Castaneda
AN-9-111-01

Rib Retractor lateral blades 10,5 x 32 mm
spreading 65 mm
Size 1,



Finochietto (modif.)
AN-9-112-01

Rib Retractor lateral blades 14 x 15 mm
spreading 120 mm
Size 1,



Cardiovascular



Haight
AN-9-113-90
Rib Retractor lateral blades 30 x 30 mm
spreading 120 mm
Size 1,



Morse-Favaloro
AN-9-114-01
Sternal Retractor 4 movable blades 17 x 22
mm spreading 160 mm Sternal Retractor
Size 1,



Morse
AN-9-115-00
Sternal Retractor 4 movable blades 22 x 27
mm spreading 200 mm
Size 1,



Tuffier
AN-9-116-02
Rib Retractor lateral blades 22 x 27 mm
spreading 200 mm
Size 1,

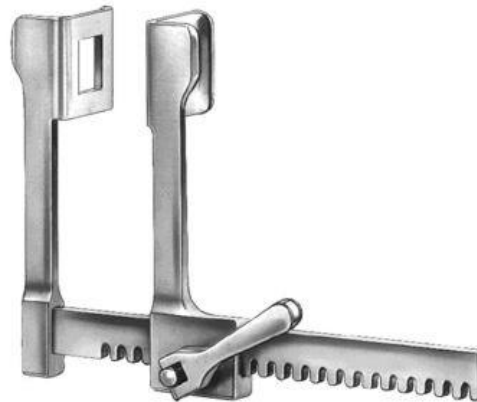

Finochietto, Baby
AN-9-117-75
Rib Retractor lateral blades 14 x 15 mm
spreading 75 mm
Size 1,



Finochietto
AN-9-118-01
Rib Retractor lateral blades 30 x 45 mm
spreading 150 mm
Size 1,



Cardiovascular



DeBakey
AN-9-119-00
Rib Retractor spreading 150 mm
Size 1,



DeBakey
AN-9-120-00
Rib Retractor spreading 200 mm
Size 1,



AN-9-121-00
Thoracic Retractor
Size 1,



Sellors
AN-9-122-19
Rib Contractor
20 cm,



Bailey-Baby
AN-9-123-14
Rib Contractor
15.5 cm,



Bailey
AN-9-124-16
Rib Contractor
20 cm,



Cardiovascular



Bailey-Gibbon
AN-9-125-16
Rib Contractor
20 cm,



Allison
AN-9-126-30
Lung Spatula
29.5 cm, 32.5 cm,



Price-Thomas
AN-9-127-22
Bronchus Clamp
22 cm,

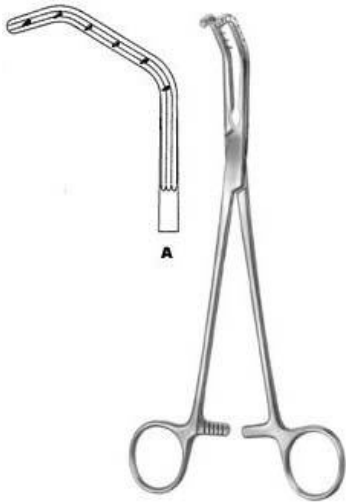

Price-Thomas
AN-9-128-22
Bronchus Clamp
22 cm,

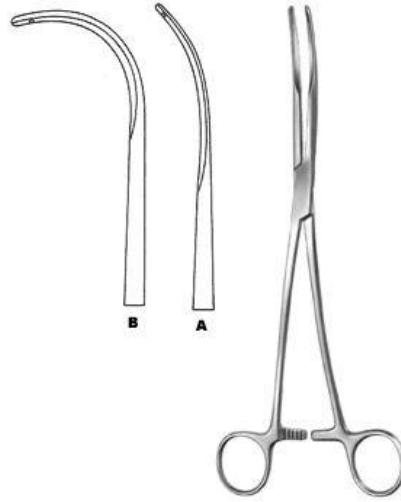

Semb
AN-9-129-24
Bronchus Clamp
24.5 cm,

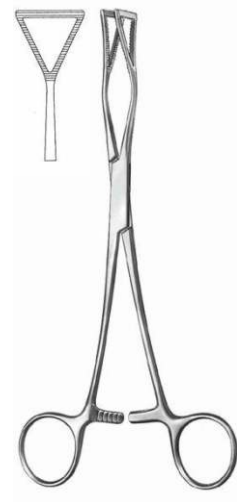

Lovlace
AN-9-130-20
Lung Grasping Forceps
20.5 cm,



Cardiovascular

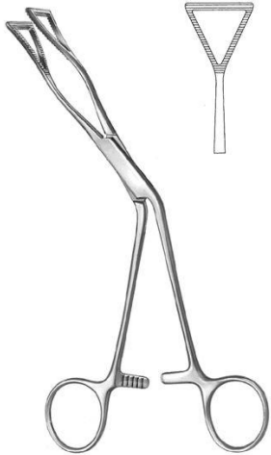

Lovelace
AN-9-131-20
Lung Grasping Forceps
19 cm,



DeBakey-Satinsky
AN-9-132-07
Bulldog Clamp
7 cm, 9 cm,



Glover
AN-9-133-06
Bulldog Clamp
6 cm,



Santulli
AN-9-134-07
Bulldog Clamp
7 cm,



Gregory, soft
AN-9-135-09
Bulldog Clamp
9 cm, 11 cm,



Gregory
AN-9-136-01
Bulldog Clamp
10.5 cm,



Cardiovascular



DeBakey-Rankin
AN-9-137-16
Haemostatic Forceps
16 cm,



DeBakey-Mosquito
AN-9-138-15
Haemostatic Forceps
15 cm,



Ochsner
AN-9-139-23
Aortic Clamp
23.5 cm,



Diethrich
AN-9-140-21
Aortic Clamp
22 cm,

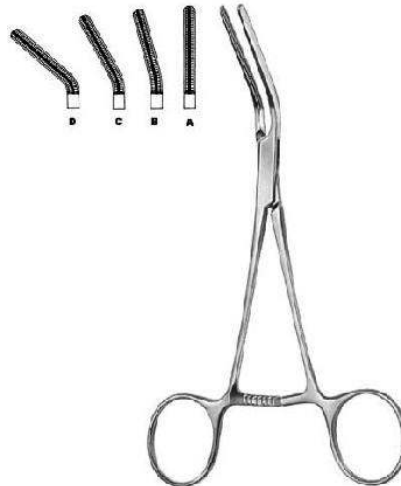

Dardik
AN-9-141-00
Multi purpose Vascular Clamp
15 cm,



Dale
AN-9-142-18
Peripheral Vascular Clamp
18 cm,



Cardiovascular

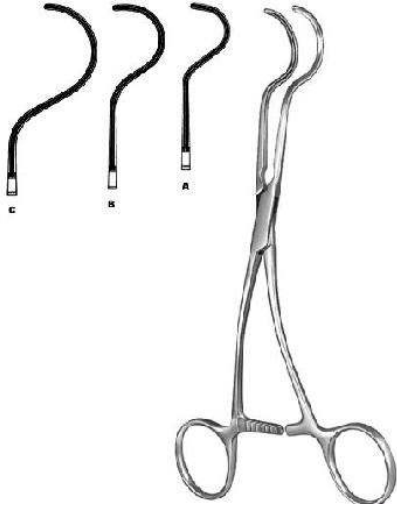

Dale
AN-9-143-17
Peripheral Vascular Clamp
17.5 cm,

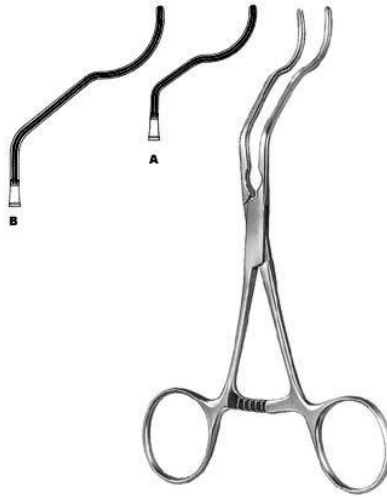

Gregory
AN-9-144-14
Profunda Clamp
13 cm, 16 cm, 18 cm,

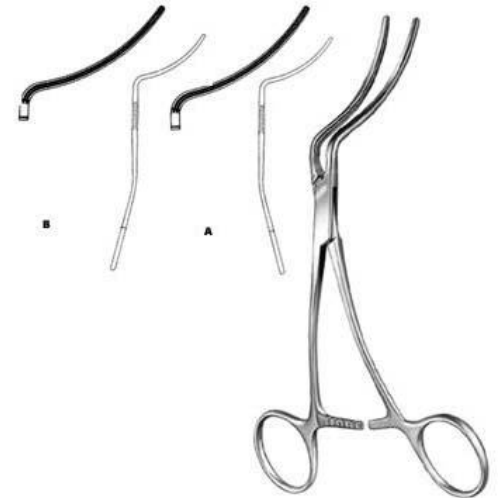

Martin
AN-9-145-16
Peripheral Vascular Clamp
16.5 cm,



Husfeldt
AN-9-146-18
Peripheral Vascular Clamp
17.5 cm,



Husfeldt
AN-9-147-18
Peripheral Vascular Clamp
18 cm,



Husfeldt
AN-9-148-17
Peripheral Vascular Clamp
17 cm,



ANARIF CO OÜ
Trader & Supplier

SURGICAL INSTRUMENTS



DeBakey
AN-9-149-16
Vascular Forceps
16 cm,



DeBakey
AN-9-150-16
Vascular Forceps
16 cm,



DeBakey
AN-9-151-16
Vascular Forceps
16 cm,

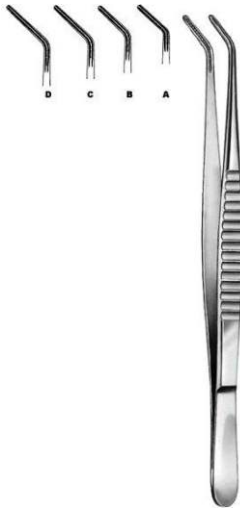

DeBakey
AN-9-152-16
Vascular Forceps
16 cm,



DeBakey
AN-9-153-16
Vascular Forceps
16 cm,



DeBakey
AN-9-154-07
Bulldog Clamp
7.5 cm,



Cardiovascular



DeBakey
AN-9-155-07
Bulldog Clamp
7.5 cm,



AN-9-156-23
Applying Forceps
23.5 cm,

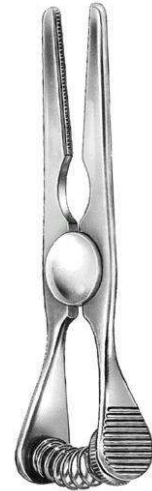

Glover
AN-9-157-06
Bulldog Clamp
7 cm,



Glover
AN-9-158-06
Bulldog Clamp
6.5 cm,

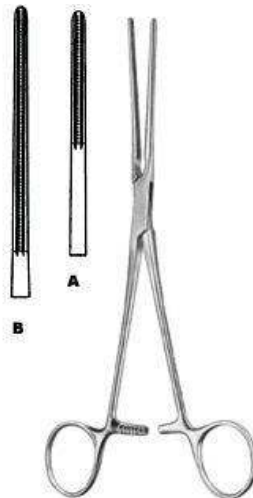

Potts
AN-9-159-21
Coarctation Clamp
21 cm,

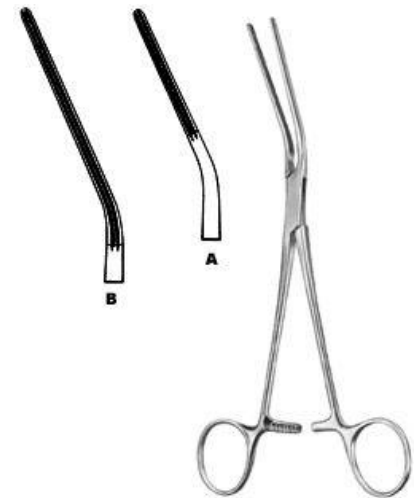

Potts
AN-9-160-21
Coarctation Clamp
20.5 cm,



Cardiovascular

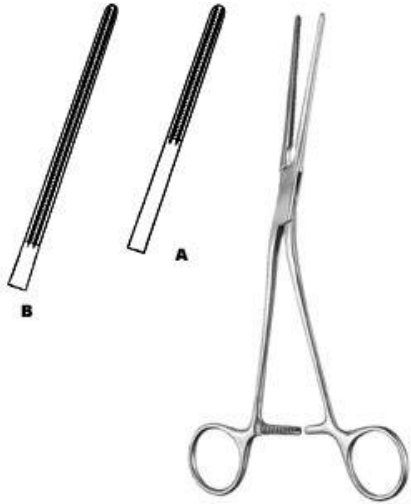

Potts
AN-9-161-21
Coarctation Clamp
20.5 cm,



Potts
AN-9-162-22
Anastomosis Clamp
21.5 cm,



Potts
AN-9-163-22
Anastomosis Clamp
22 cm,

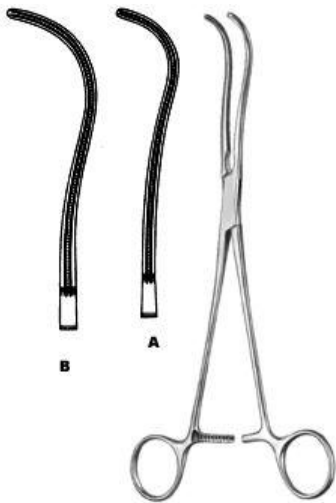

DeBakey
AN-9-164-19
Ligature Forceps
19 cm,



DeBakey
AN-9-165-16
Peripheral Vascular Clamp
16 cm,



DeBakey
AN-9-166-19
Peripheral Vascular Clamp
16 cm,



Cardiovascular

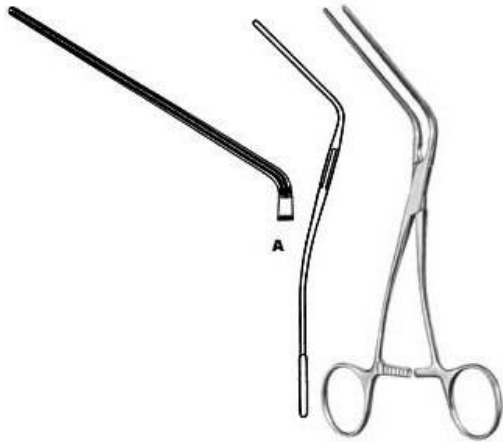

Leland-Jones
AN-9-167-18
Peripheral Vascular Clamp
18 cm,



Bainbridge
AN-9-168-15
Multi purpose Vascular Clamp
15 cm,



Bainbridge
AN-9-169-15
Multi purpose Vascular Clamp
15 cm,

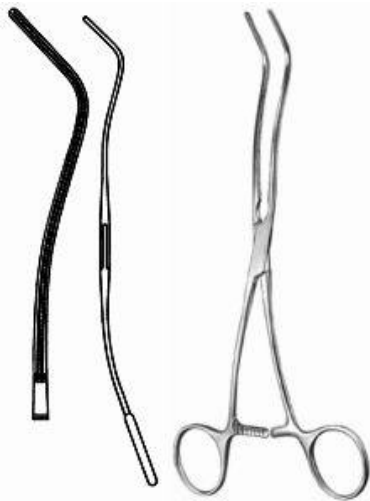

DeBakey
AN-9-170-20
Multi purpose Vascular Clamp
20 cm,



DeBakey
AN-9-171-26
Aortic Aneurysm Clamp
26 cm,



DeBakey
AN-9-172-28
Aortic Aneurysm Clamp
28 cm,



Cardiovascular



DeBakey
AN-9-173-30
Aortic Aneurysm Clamp
30 cm,



DeBakey
AN-9-174-27
Aortic Clamp
27 cm,



DeBakey
AN-9-175-24
Ligature Forceps
24.5 cm,



DeBakey
AN-9-176-24
Ligature Forceps
24.5 cm,



DeBakey
AN-9-178-25
Ligature Forceps
27 cm,

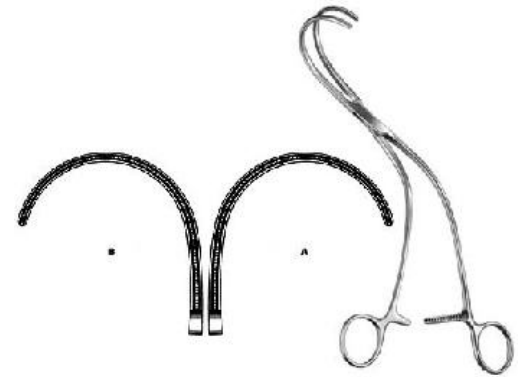

Weber
AN-9-179-01
Aortic Clamp
24 cm,



Cardiovascular



Satinsky
AN-9-180-20
Tangential Occlusion Clamp
22 cm,



Harken
AN-9-181-01
Auricle Clamp
24.5 cm,



Lees
AN-9-182-23
Bronchus Clamp
23 cm,



Lees
AN-9-183-25
Bronchus Clamp
25 cm,



Lambert-Kay
AN-9-184-21
Anastomosis Clamp
22.5 cm,



DeBakey
AN-9-185-17
Anastomosis Clamp
16.5 cm,



Cardiovascular



Morris-DeBakey
AN-9-186-18
Aortic Clamp
16.5 cm,



DeBakey-Bahnson
AN-9-187-23
Aneurysm Clamp
23.5 cm,

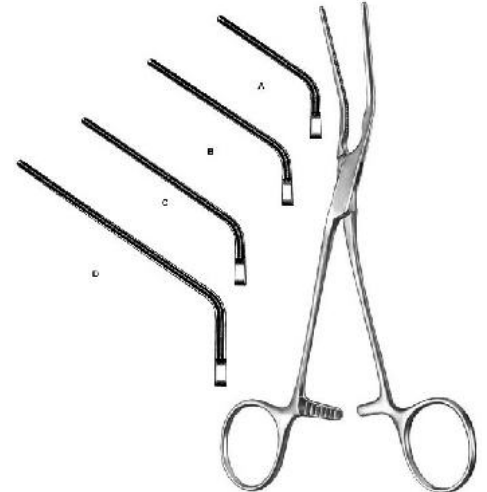

DeBakey
AN-9-188-20
Multi purpose Vascular Clamp
18 cm,

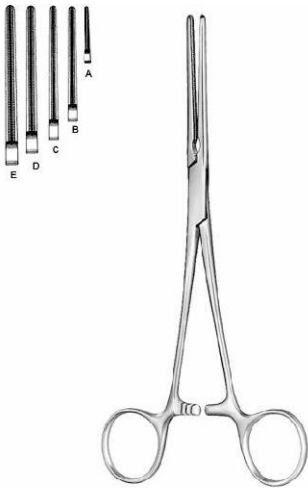

DeBakey-Mosquito
AN-9-189-12
Haemostatic Forceps
12.5 cm,

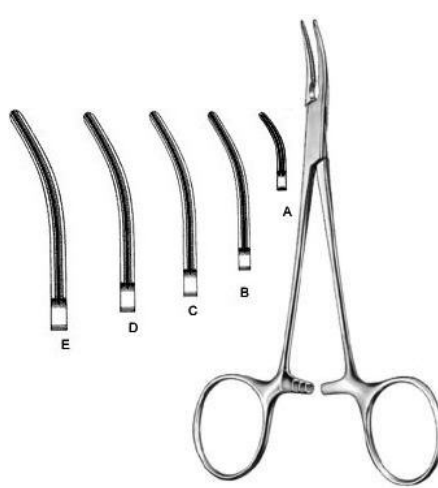

DeBakey-Mosquito
AN-9-190-12
Haemostatic Forceps
12.5 cm,



DeBakey
AN-9-191-17
Multi purpose Vascular Clamp
17 cm,



Cardiovascular



DeBakey
AN-9-192-16
Multi purpose Vascular Clamp
16.5 cm,

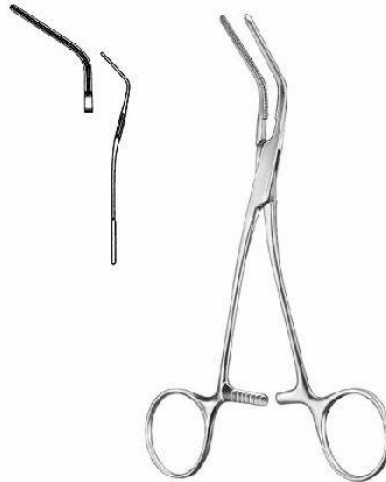

DeBakey
AN-9-193-15
Multi purpose Vascular Clamp
16 cm,



DeBakey
AN-9-194-15
Multi purpose Vascular Clamp
16.5 cm,



DeBakey
AN-9-195-17
Multi purpose Vascular Clamp
16.5 cm,



Glover
AN-9-196-17
Multi purpose Vascular Clamp
17 cm,



Glover
AN-9-197-17
Multi purpose Vascular Clamp
17.5 cm,



Cardiovascular

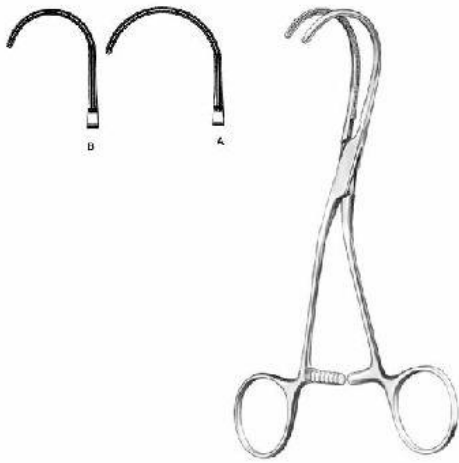

DeBakey
AN-9-198-16
Multi purpose Vascular Clamp
16.5 cm,

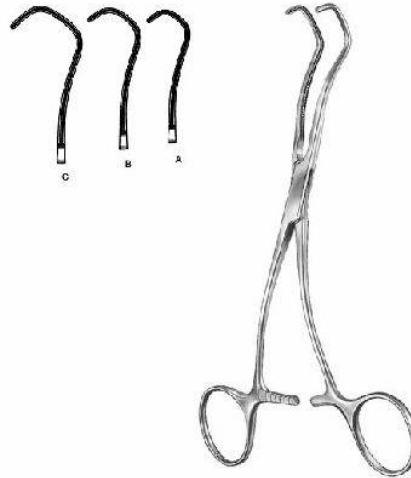

Derra
AN-9-199-16
Anastomosis Clamp
16.5 cm Fig. 1, 17 cm Fig. 2, 18 cm Fig. 3,



DeBakey-Beck
AN-9-200-17
Anastomosis Clamp
17 cm,



Cooley
AN-9-201-16
Vascular Forceps
16 cm,

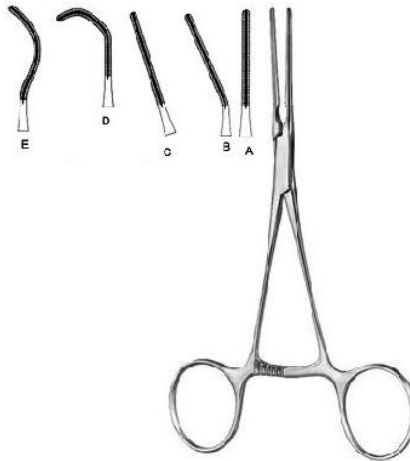

Cooley
AN-9-202-01
Pediatric Vascular Clamp
14.5 cm,



Cooley
AN-9-203-21
Iliac Clamp
22 cm,



Cardiovascular

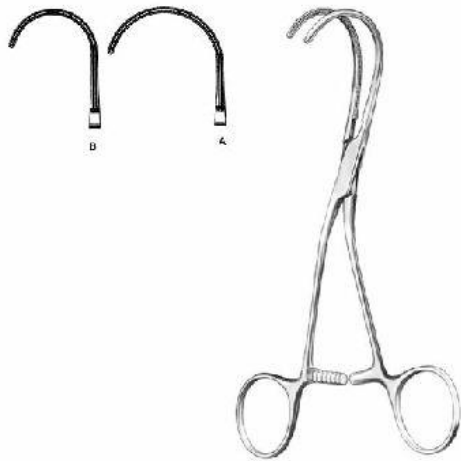

DeBakey
AN-9-198-16
Multi purpose Vascular Clamp
16.5 cm,

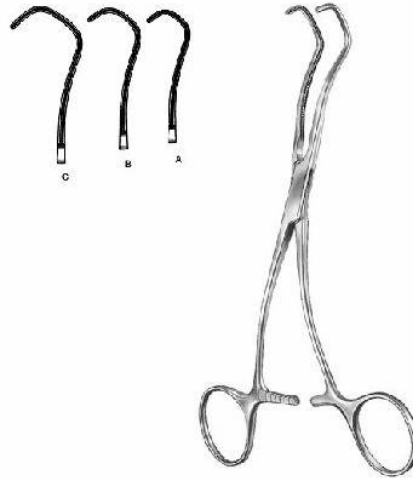

Derra
AN-9-199-16
Anastomosis Clamp
16.5 cm Fig. 1, 17 cm Fig. 2, 18 cm Fig. 3,



DeBakey-Beck
AN-9-200-17
Anastomosis Clamp
17 cm,



Cooley
AN-9-201-16
Vascular Forceps
16 cm,

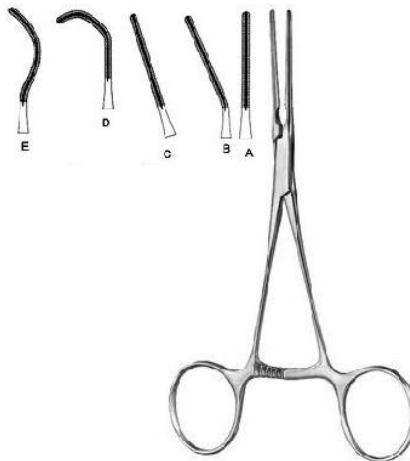

Cooley
AN-9-202-01
Pediatric Vascular Clamp
14.5 cm,



Cooley
AN-9-203-21
Iliac Clamp
22 cm,



Cardiovascular



Cooley
AN-9-204-17
Anastomosis Clamp
17 cm,

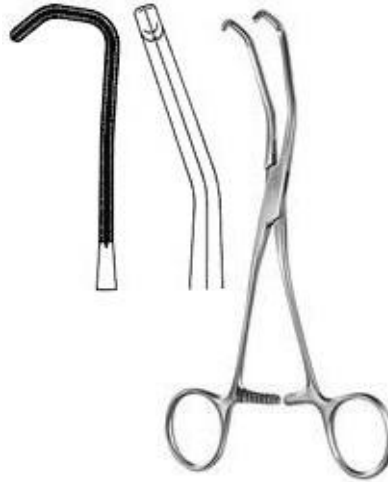

Cooley
AN-9-205-17
Anastomosis Clamp
20 cm,



Cooley
AN-9-206-16
Anastomosis Clamp
17 cm,



Cooley
AN-9-207-15
Multi purpose Vascular Clamp
16 cm,



Cooley
AN-9-208-17
Multi purpose Vascular Clamp
17 cm,



Cooley
AN-9-209-17
Multi purpose Vascular Clamp
17 cm,



Cardiovascular



Cooley
AN-9-210-17
Multi purpose Vascular Clamp
17.5 cm,

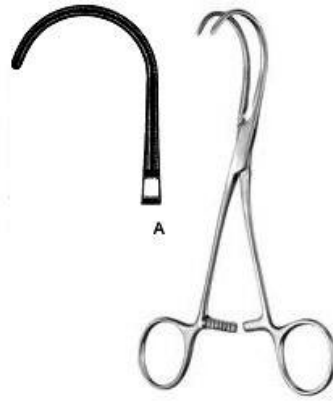

Cooley
AN-9-211-16
Multi purpose Vascular Clamp
16.5 cm,



Cooley-Derra
AN-9-212-16
Anastomosis Clamp
16.5 cm,



Cooley-Beck
AN-9-213-17
Anastomosis Clamp
17 cm,

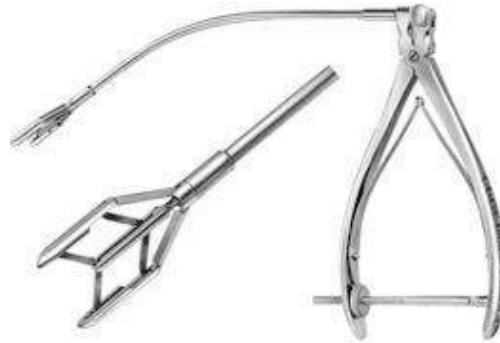

Cooley
AN-9-214-00
Aortic Dilator



Cooley
AN-9-215-05
Vascular Dilator
13 cm 0,5 mm ?,



Cardiovascular



DeBakey
AN-9-216-05
Vascular Dilator
19 cm 0,5 mm ?,

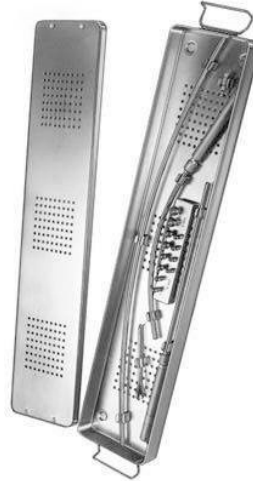

Martin
AN-9-217-00
Tunneling Set complete set with three shafts,
two handles and 12 tips in storage case.



Hach
AN-9-218-01
Fasciotomy Knife with plastic handle
30 cm,



AN-9-219-18
Intima Spatula
18.5 cm,

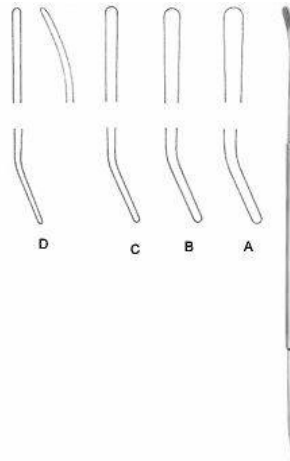

Robb
AN-9-220-01
Vascular Dissector
24 cm Fig. 1 2,5 mm ?, 24 cm Fig. 2 2,0 mm



Crile
AN-9-221-20
Nerve Hooklet
20 cm,



ANARIF CO OÜ
Trader & Supplier

SURGICAL INSTRUMENTS

Hospital Uniforms



AN-9-216-06
Doctor Uniform



AN-9-217-01
Lab coats



AN-9-218-02
Surgical gowns



AN-9-219-18
Patient Gowns



AN-9-220-01
Scrub Suit



AN-9-221-20
Nurse Uniform



ANARIF CO OÜ
Trader & Supplier

SURGICAL INSTRUMENTS

Hospital Bed Sheet



AN-9-216-06
Bed Sheet



AN-9-217-01
Bed Linen



AN-9-217-04
Bed Linen



AN-9-217-06
Hospital Bed Sheet



ANARIF CO OÜ
Trader & Supplier

SURGICAL INSTRUMENTS

Hospital Towels



AN-9-216-06
Hospital Towels



AN-9-216-08
Hospital Towels



AN-9-217-09
Hospital Towels



ANARIF CO OÜ

Trader & Supplier

CONTACT US

 +968 94101520 | +968 97856407

 info@anarifco.com | sales@anarifco.com

 ladher41@gmail.com

 www.anarifco.com

 Harju maakond, Tallinn, Mustamäe
linnaosa, Akadeemia tee 7/2-314, 12611